

Addison Queen/King Bookcase Headboard

DUET finish

Assembly Instructions

Model #

3839DUETb

Addison Queen Bookcase Headboard

3842DUETb

Addison King Bookcase Headboard

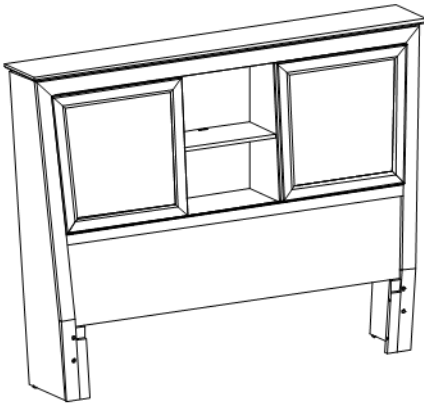

Thank you for allowing us to help you furnish your home. We are certain you will be delighted with your new furniture for many years to come.

IMPORTANT NOTES:

- Wood can be susceptible to changing color over time when exposed to strong sunlight. Use window shades, drapes or blinds to protect your furniture. To help the surface age evenly and avoid dark and light spots, periodically move items to expose the entire surface to an even amount of light so it may develop a uniform patina.
- For normal household use only. *Not* recommended for commercial use.
- Remove items before you move this unit.
- Do not overload the concealed storage areas.
- Use care when operating the soft-close sliding doors. Minimal effort is required for doors to perform.
- This assembly requires two people.

WARNING

Drilling, sawing, sanding or machining wood products can expose you to wood dust, a substance known to the state of California to cause cancer. Avoid inhaling wood dust or use a dust mask or other safeguards for personal protection.

For more information go to: www.p65warnings.ca.gov/wood

This product can expose you to chemicals, including formaldehyde, which are known to the State of California to cause cancer.

For more information go to: www.p65warnings.ca.gov/furniture

A/C Dual Port USB WALL CHARGER: CAUTION: Changes or modifications not approved by the party responsible for compliance could void user's authority to operate the equipment.

NOTE: This equipment has been tested and found to comply with the limits for a Class B digital device, pursuant to part 15 of the FCC Rules. These limits are designed to provide reasonable protection against harmful interference in a residential installation. This equipment generates, uses and can radiate radio frequency energy and, if not installed and used in accordance with the instructions, may cause harmful interference to radio communications. However, there is no guarantee that interference will not occur in a particular installation. If this equipment does cause harmful interference to radio or television reception, which can be determined by turning the equipment off and on, the use is encouraged to try to correct the interference by one or more of the following measures:

- Reorient or relocate the receiving antenna.
- Increase the separation between the equipment and receiver
- Connect the equipment into an outlet on a circuit different from that to which the receiver is connected.

Consult the dealer or an experienced radio/TV technician for help.

DESIGN SUBJECT TO CHANGE WITHOUT NOTICE.

CUSTOMER SERVICE

If you ever have questions about your furniture, please do not hesitate to contact us. In the unlikely event you need a replacement part; we can make those parts available through an authorized Whittier Wood Furniture dealer. If you cannot order replacement parts through your dealer, please contact our customer service department.

Hours: Our friendly customer service staff can be reached:

Monday-Friday 8:00 a.m. to 5:00 p.m. (Pacific Time).

You may leave a message 24 hours a day, seven days a week.

Customer Service: 800-653-3336 • Outside the U.S.: 541-687-0213

Fax: 541-687-2060 • Email: info@whittierwood.com

**Whittier
Wood**
FURNITURE

P.O. Box 2827
Eugene, OR 97402 USA











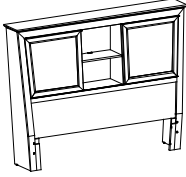
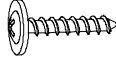
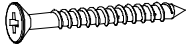







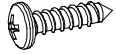



Production Code:

VN





09/23

3839DUETb Addison Queen Bookcase Headboard
3842DUETb Addison King Bookcase Headboard
Parts List

Please identify the parts and check that quantities received match those on this list.
 If you need to replace a part, refer to the following letter and part name.

Part	Description	Quantity	
		3839DUETb	3842DUETb
Ab	Headboard Assembly 	1	1
K	#8 x 7/8" Black Lo-Profile Screw (inserted) 	14	18
M	#8 x 1-5/8" Black Screw (inserted) 	4	4
Y	5/16" x 14mm Insert Nut (inserted) 	4	4
YA	#8 x 2-1/4" Black Screw (inserted) 	4	4
YB	60mm Long Strap (installed) 	4	4
YC	#6 x 1/2" Undercut Screw AB (inserted) 	8	8
YD	Washer (installed) 	8	8
YE	#6 x 3/4" Flat Head Screw (inserted) 	16	16
YF	#6 x 5/8" Undercut Screw ZN (inserted) 	16	16
YG	#14 x 3/4" Pan Head Screw 	6	6
YH	18mm Washer 	6	6
ZH	Short Aluminum Track Rail (installed) 	1	1
ZI	Long Aluminum Track Rail (installed) 	1	1
ZJ	Roller (installed) 	8	8
ZK	Soft Close Damper (installed) 	2	2
ZL	#8 x 5/8" Pan Head Screw (inserted) 	8	8
ZM	#8 x 1-3/8" Lo-Profile Screw (inserted) 	20	24
ZO	Power Supply (attached) 	1	1
ZP	A/C Dual Port (attached) 	1	1
ZQ	Corner Brace (attached) 	2	2
ZR	Large Adjustable Glide (installed) 	2	2
ZS	Tack Glide (attached) 	4	4
ZT	Top Assembly (attached) 	1	1

3839DUETb Addison Queen Bookcase Headboard
3842DUETb Addison King Bookcase Headboard
Parts List

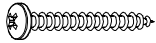
Part	Description	Quantity	
		3839DUETb	3842DUETb
ZUa	Left Door (installed) 	1	1
ZVa	Right Door (installed) 	1	1
ZW	False Bottom (installed) 	2	2
ZX	#6 x 5/8" Philtruss Screw (inserted) 	2	2
ZY	#8 x 1-1/4" Pan Head Screw (inserted) 	2	2

3839DUETb Addison Queen Bookcase Headboard 3842DUETb Addison King Bookcase Headboard

Assembly Instructions

This assembly requires two people.

Tools Required: Drill, 1/8" bit, Phillips screwdriver, Slotted screwdriver

Note: Use this instruction and hardware kit if you are attaching 3839DUETb or 3842DUETb to a Hollywood frame. IF you are using this product for Storage Bed assembly- Pedestal/Footboard Kits or Rail Kits, disregard this instruction and hardware and use what is included in your Footboard kit.

1. Adjust the Hollywood frame to fit your mattress and box spring.
2. Place the Headboard (Ab) against the end brackets of the Hollywood frame and mark the locations for the screws. Drill pilot holes approximately 3/4" deep. To make sure you don't drill deeper, measure 3/4" up from the end of the drill bit and wrap a piece of tape around the bit. Stop drilling when the edge of the tape meets the wood.
3. Position the Headboard (Ab) against the frame and attach using six #14 x 3/4" Pan Head Screws (YG) and six 18mm Washers (YH).
4. Place your bed in its final position. To level the headboard, reach behind the bookcase front legs and, using a slotted screwdriver, find the Large Adjustable Glide (ZR). Using a slotted screwdriver, rotate the Large Adjustable Glides (ZR) clockwise until they bear weight. See Figures 4, 4a and 4b.

This is important if the bookcase headboard sits upon a carpet tack strip.

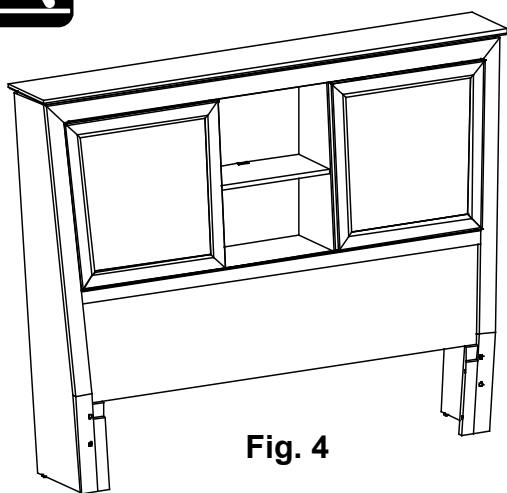

Fig. 4
Hollywood bed frame removed for illustration purposes.

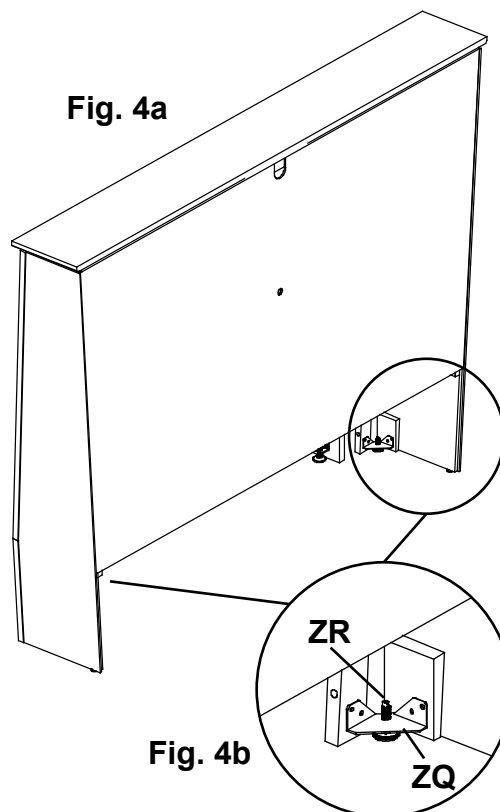

Fig. 4a
Fig. 4b
The top of the Large Adjustable Glide (ZR) is slotted.