

Model #

1143DUETg

Addison

6-Drawer Chest

DUET finish

Assembly Instructions

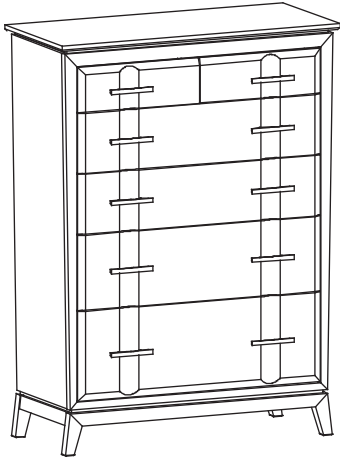

Thank you for allowing us to help you furnish your home. We are certain you will be delighted with your new furniture for many years to come.

IMPORTANT NOTES:

- Wood can be susceptible to changing color over time when exposed to strong sunlight. Use window shades, drapes or blinds to protect your furniture. To help the surface age evenly and avoid dark and light spots, periodically move items to expose the entire surface to an even amount of light so it may develop a uniform patina.
- For normal household use only. *Not* recommended for commercial use.
- Do not remove or modify the counterweight. It is an important part of the stability and safety system.
- Do not overload the drawers.
- Unload items before you move this unit.
- This assembly requires two people.

! WARNING		
	<p>Children have died from furniture tipover. To reduce the risk of furniture tipover:</p> <ul style="list-style-type: none"> • ALWAYS install Anti-tip device provided. • NEVER put a TV on this product. 	<p>DO NOT remove the interlock system except for maintenance as shown. NEVER use the unit without the interlock installed following the instructions.</p>
	<ul style="list-style-type: none"> • NEVER allow children to stand, climb or hang on any drawers, doors or shelves. • NEVER open more than one drawer at a time. • DO NOT defeat or remove the drawer interlock system; it is an important stability and safety system. • Place heaviest items in the lowest drawers. 	<p>The snapper arm must be angled forward in the locked positions to engage the interlock system after removing a drawer. See diagram below.</p> <div style="text-align: center;"> <p>Close up view of locked snapper</p> </div>
<p>Drilling, sawing, sanding or machining wood products can expose you to wood dust, a substance known to the state of California to cause cancer. Avoid inhaling wood dust or use a dust mask or other safeguards for personal protection. For more information go to: www.p65warnings.ca.gov/wood This product can expose you to chemicals, including formaldehyde, which are known to the State of California to cause cancer. For more information go to: www.p65warnings.ca.gov/furniture</p>		

DESIGN SUBJECT TO CHANGE WITHOUT NOTICE.

CUSTOMER SERVICE

If you ever have questions about your furniture, please do not hesitate to contact us. In the unlikely event you need a replacement part; we can make those parts available through an authorized Whittier Wood Furniture dealer. If you cannot order replacement parts through your dealer, please contact our customer service department.

Hours: Our friendly customer service staff can be reached:

Monday-Friday 8:00 a.m. to 5:00 p.m. (Pacific Time).

You may leave a message 24 hours a day, seven days a week.

Customer Service: 800-653-3336 • **Outside the U.S.:** 541-687-0213

Fax: 541-687-2060 • **Email:** info@whittierwood.com









P.O. Box 2827
Eugene, OR 97402 USA

Production Code:	
VN	07/23

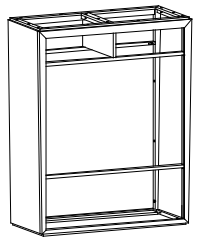
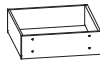
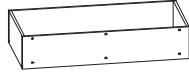

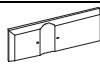
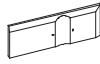
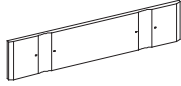
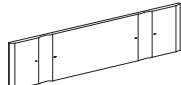
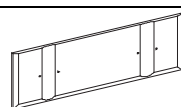
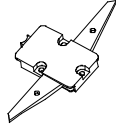



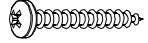
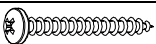
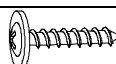



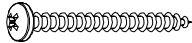









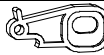

1143DUETg Addison 6-Drawer Chest

Parts List

Please identify the parts and check that quantities received match those on this list.
If you need to replace a part, refer to the following letter and part name.

Part	Description		Quantity
Ac	Top Assembly		1
Bd	Case		1
Cf	Left/Right Top Drawer Box (inserted)		2
Df	Small Lower Drawer Box (inserted)		2
Ef	Medium Lower Drawer Box (inserted)		1
Ff	Large Lower Drawer Box (inserted)		1
G	Left Top Drawer Face (installed)		1
H	Right Top Drawer Face (installed)		1
I	Small Lower Drawer Face (installed)		2
J	Medium Lower Drawer Face (installed)		1
K	Large Lower Drawer Face (installed)		1
L	Anti-Tip Snapper (attached)		2
M	Drawer Clip (attached)		4
Nb	14" Drawer Slides (pre-installed sets)		4
O	#6 x 3/4" Philtruss Screw (inserted)		42
P	#6 x 1/2" Philtruss Screw (inserted)		48
R	#8 x 1" Pan Head Screw (inserted)		22
S	#8 x 1-1/4" Pan Head Screw (inserted)		9
T	#8 x 7/8" Black Lo-Profile Screw (inserted)		52

1143DUETg Addison 6-Drawer Chest Parts List

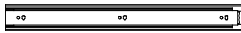
Part	Description		Quantity
U	#8 x 1-3/4" Pan Head Screw (inserted)		12
V	#8 x 1-1/4" Black Screw (inserted)		5
W	#8 x 1-5/8" Machine Screw Tuscan (installed)		20
ZA	1/4" x 20mm Insert Nut (inserted)		4
ZB	5/32" x 10mm Insert Nut (inserted)		20
ZC	Black Walnut Pull (attached)		10
ZE	Base (attached)		1
ZF	Front 4-Hole Bracket (attached)		2
ZG	Back 6-Hole Bracket (attached)		2
ZH	#6 x 3/4" Brass Flat Head Screw (inserted)		20
ZI	#8 x 1-5/8" Black Screw (inserted)		8
ZK	#8 x 1-3/8" Lo-Profile Screw (inserted)		17
ZL	Slotted Leveler (installed)		4
ZM	Leveler Adjustment Key (attached to Owners Manual)		1
ZN	Linkage Arm (attached)		2
ZO	Aluminum Support Bar (attached)		1
ZP	#6 x 5/8" Philtruss Screw (inserted)		6
ZQ	1/4" Hex Nut (inserted)		2
ZR	1/4" T-Nut (inserted)		12
ZT	1/4" x 25mm Hex Bolt (inserted)		12
ZU	1/4" x 18mm Hex Bolt (inserted)		2
ZW	Washer (inserted)		2
ZX	12" Drawer Slides (pre-installed sets)		2
TS	Furniture Tipping Restraint (attached)		1 set

1143DUETg Addison 6-Drawer Chest

Assembly Instructions

Tools Required: Phillips Screwdriver, Pencil.

Tool Provided: Leveler Adjustment Key in the Zip bag taped to the Owner's Manual and Safety Guide.

1. Remove screws from the plywood supports and side aprons. Recycle or discard. See Figure 1.

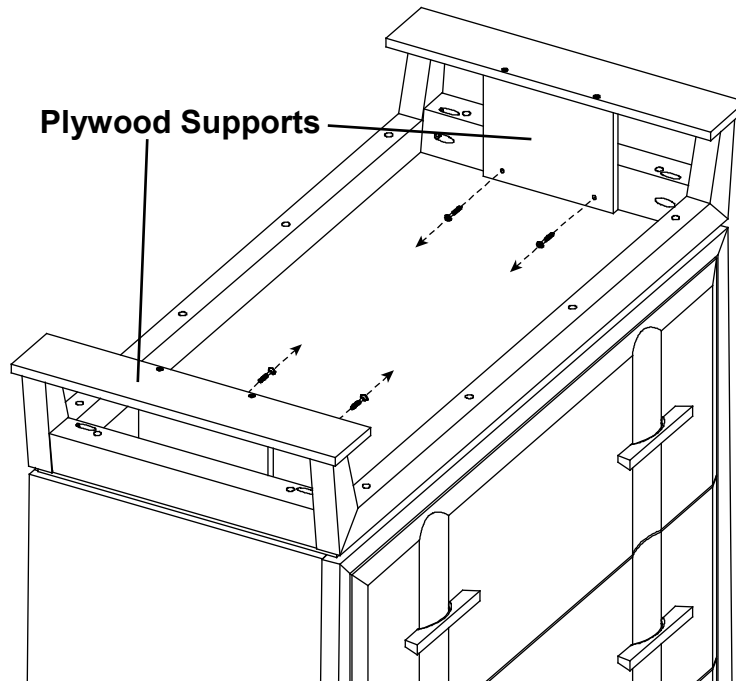

Fig. 1

2. Place the unit at its final destination. Use the Leveler Adjustment Key (ZM), found in the Zip bag taped to the Owner's Manual and Safety Guide to rotate the Slotted Levelers (ZL) on the bottoms of the legs until the unit is level. See Figures 2 and 2a.



Fig. 2

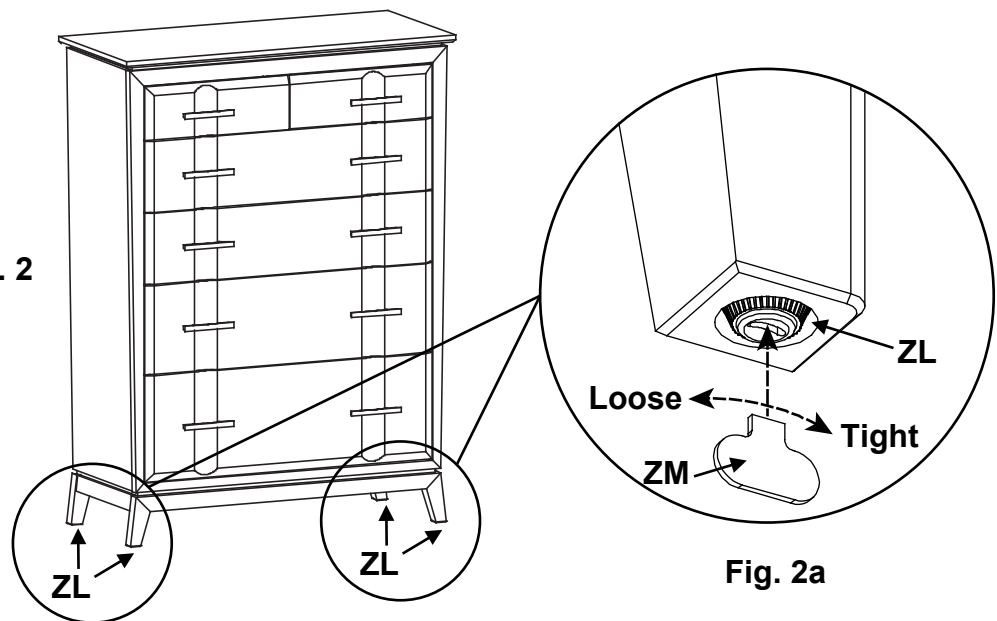
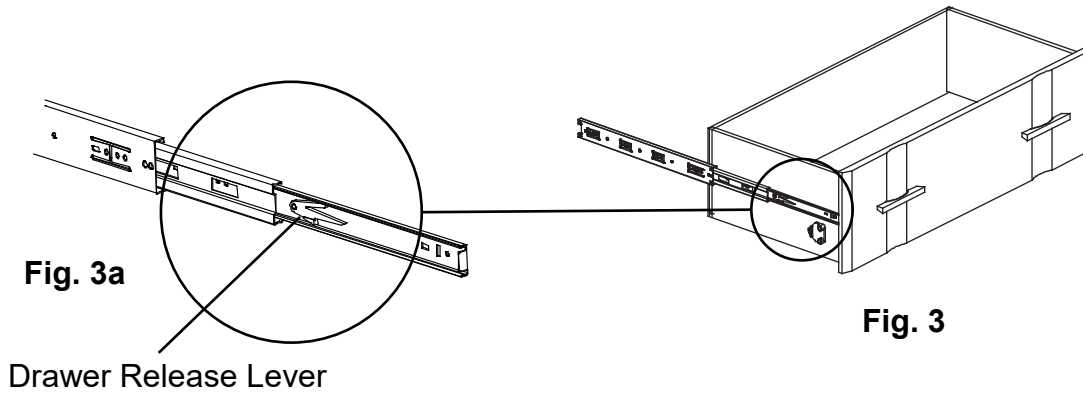

Fig. 2a

1143DUETg Addison 6-Drawer Chest

Assembly Instructions

3. If you need to remove your drawers, pull up on the left Drawer Release Lever while pushing down on the right Drawer Release Lever and pull out the drawer. See Figures 3 and 3a. Note where each drawer came from to make sure you place them back into their correct positions.



4. This piece of furniture includes two drawer interlock systems, one controlling each vertical bank of drawers. This allows only one drawer in each bank to be open at a time. This safety feature reduces the risk of tip over. Do not defeat or remove the drawer interlock systems.
5. When removing drawers from furniture featuring the Anti-Tip Drawer Interlock System it is important that the drawer be installed in its original location. Numbers and letters are stamped on the back of the drawers. Stamping sequence starts at the bottom, moves to the top and designated left or right.

Drawer back stamping example:

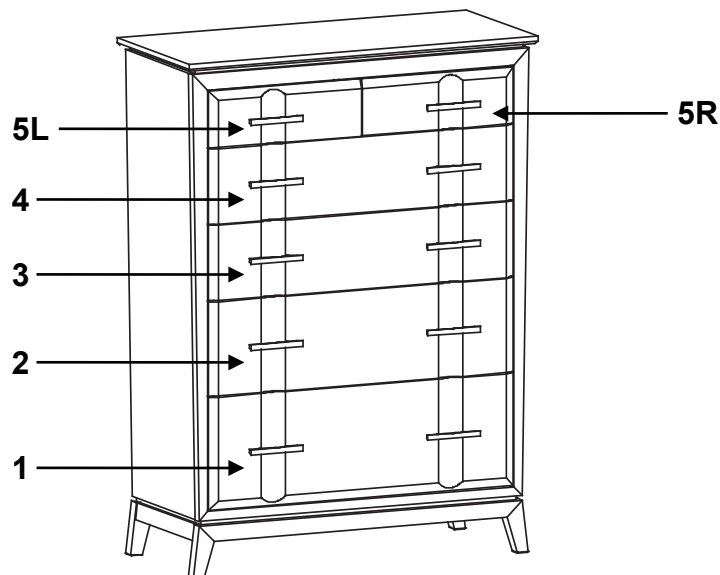

1143DUETg Addison 6-Drawer Chest

Assembly Instructions

6. The drawer interlock system has two major parts; drawer clips attached to the sides of the drawers and anti-tip snapper arms attached to the side panels as shown in Figure 6. If you want to remove more than one of the secured drawers, you have to change the position of the snapper arm to ensure it is unlocked.

When you open a secured drawer, the snapper arm will be angled forward. See Figure 6a. Remove the drawer. Push the snapper arm back so it is straight. See Figure 6b. Now you can remove another drawer adjacent to the one already removed.

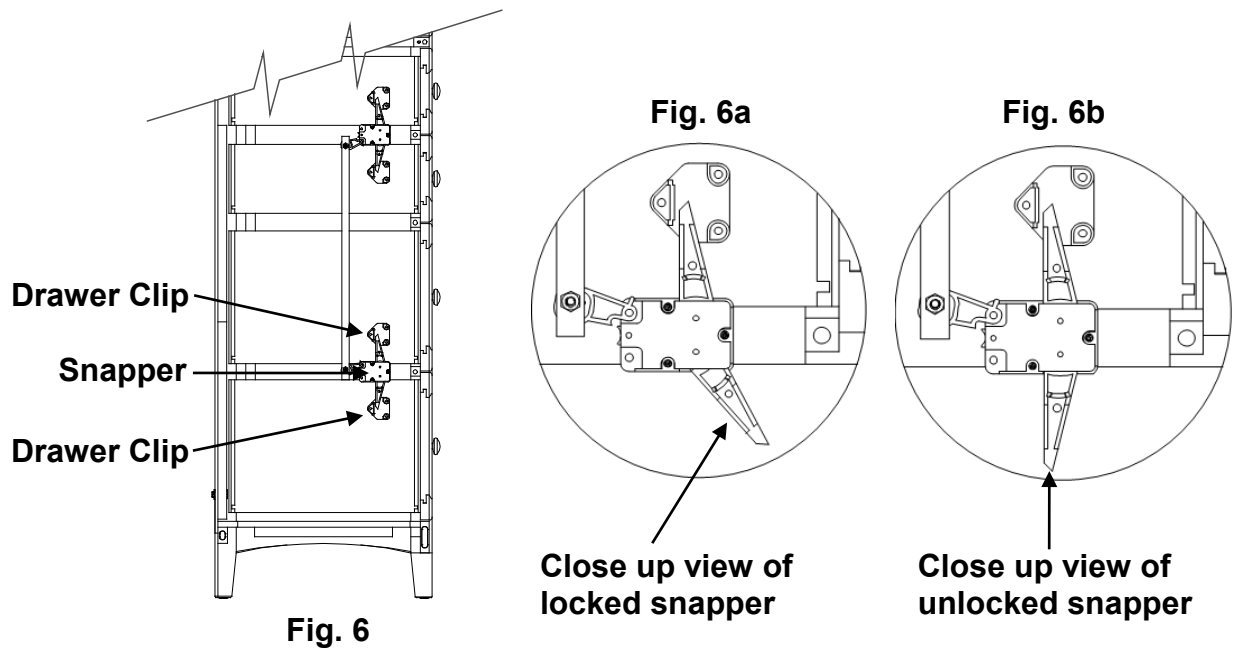





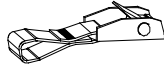
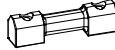

Continued on Page 7

Furniture Tipping Restraint Instructions

! **Safety First! Anchor It!** !

Before you begin this assembly, identify each part and make sure the quantities received match what is on this list. If you need to replace a part, contact Whittier Wood Furniture customer service and refer to the following list for its name and letter code.

Part	Description	Quantity
A	Cam Buckle and Short Strap (installed) 	1
B	Plastic Bracket (installed) 	1
C	1" x 1000mm Long Strap (installed) 	1
D	#8 x 3" Pan Head Screw 	2
E	#10 x 1" Oval Head Screw (inserted) 	1
F	Washer 	1

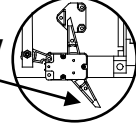
! WARNING		
	<p>Children have died from furniture tipover. To reduce the risk of furniture tipover:</p> <ul style="list-style-type: none"> ALWAYS install Anti-tip device provided. NEVER put a TV on this product. NEVER allow children to stand, climb or hang on any drawers, doors or shelves. 	<p>DO NOT remove the interlock system except for maintenance as shown. NEVER use the unit without the interlock installed following the instructions.</p>
	<ul style="list-style-type: none"> NEVER open more than one drawer at a time. DO NOT defeat or remove the drawer interlock system; it is an important stability and safety system. Place heaviest items in the lowest drawers. 	<p>The snapper arm must be angled forward in the locked positions to engage the interlock system after removing a drawer. See diagram below.</p> <div style="text-align: right; margin-top: 10px;">  <p>Close up view of locked snapper</p> </div>

1143DUETg Addison 6-Drawer Chest

Assembly Instructions

If you have a stone or tile floor or do not wish to drive screws into the corner of the baseboard and floor see the instruction included inside the tipping restraint kit for an alternate installation.

- Decide where you want to place the piece of furniture in your room. Mark the baseboard with a pencil mark directly behind the location where the tipping restraint is attached to your item. Move the item away from the wall far enough to allow you to access the spot where the baseboard meets the floor. Position the straps and Plastic Bracket (B) as shown in Figures 7 and 7a with the angled corners of the Plastic Bracket (B) firmly placed against the seam of the baseboard and floor. Attach by driving #8 x 3" Pan Head Screws (D) through the holes in the Plastic Bracket (B) into the seam below the baseboard where it meets the floor. See Figures 7 and 7a.

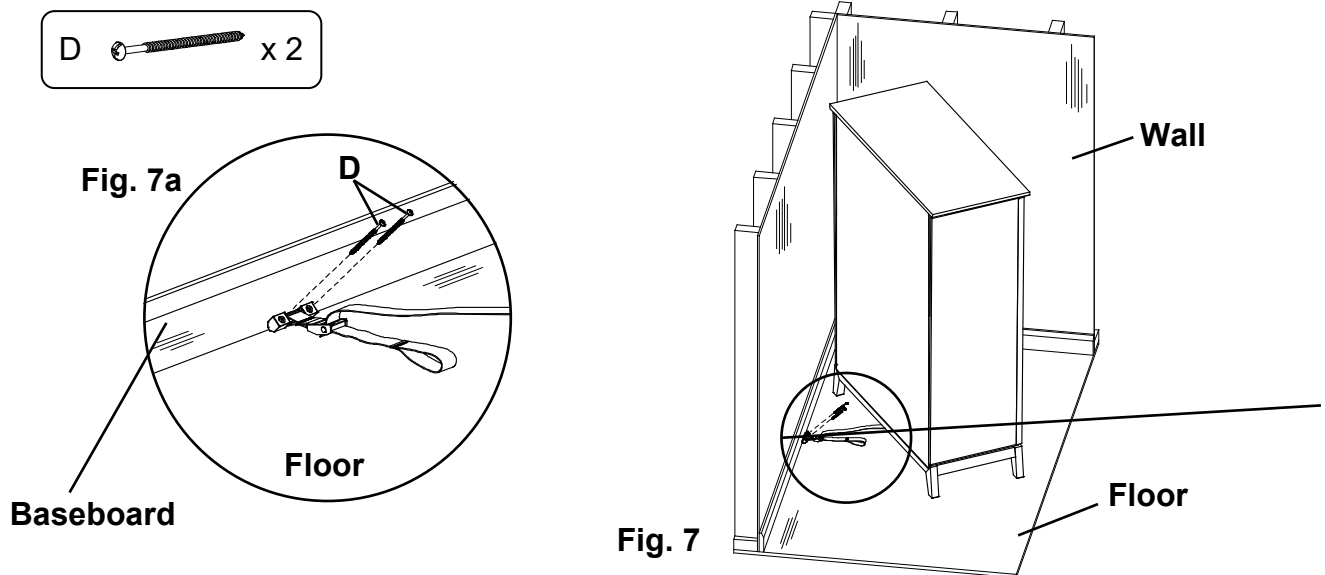

- Move the item back into position against the wall and reach underneath the piece of furniture to grasp the loop in the free end of the strap. Pull the free end of the strap until portion between the Cam Buckle (A) and the back apron of the item is tight. See Figures 8 and 8a. If you need to move the piece of furniture reach beneath and locate the buckle which connects the two sections of the strap and depress the release lever, then pull on the section of strap that is between the buckle and the back apron of the furniture until there is enough slack to allow you to pull the item away from the wall.

