

# McKenzie Chests

**GAC = Glazed Antique Cherry finish**

**JAV = Java finish**

**FST = Fieldstone finish**

**PEC = Pecan finish**

**SN = Snowbound finish**

*Assembly Instructions*

Model #

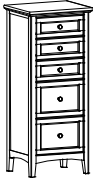

**1121f**  
**McKenzie**

**5-Drawer Lingerie Chest**



**1129g**  
**McKenzie**

**5-Drawer Tall Chest**

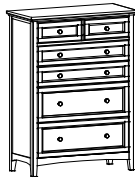

**1180i**  
**McKenzie**  
**6-Drawer Chest**

*Thank you for allowing us to help you furnish your home. We are certain you will be delighted with your new furniture for many years to come.*

## IMPORTANT NOTES:

- For normal household use only. *Not* recommended for commercial use.
- Do not remove or modify the counterweight. It is an important part of the stability and safety system.
- Do not overload the drawers.
- Unload items before you move this unit.
- This assembly requires two people.

<b>! WARNING</b>		
	<p><b>Children have died from furniture tipover. To reduce the risk of furniture tipover:</b></p> <ul style="list-style-type: none"> <li>• <b>ALWAYS</b> install Anti-tip device provided.</li> <li>• <b>NEVER</b> put a TV on this product.</li> <li>• <b>NEVER</b> allow children to stand, climb or hang on any drawers, doors or shelves.</li> <li>• <b>NEVER</b> open more than one drawer at a time.</li> <li>• <b>DO NOT</b> defeat or remove the drawer interlock system; it is an important stability and safety system.</li> <li>• <b>Place heaviest items in the lowest drawers.</b></li> </ul>	<p>DO NOT remove the interlock system except for maintenance as shown. NEVER use the unit without the interlock installed following the instructions.</p>
	<p>The snapper arm must be angled forward in the locked positions to engage the interlock system after removing a drawer. See diagram below.</p>	<p>Close up view of locked snapper</p>
<p>Drilling, sawing, sanding or machining wood products can expose you to wood dust, a substance known to the state of California to cause cancer. Avoid inhaling wood dust or use a dust mask or other safeguards for personal protection. For more information go to: <a href="http://www.p65warnings.ca.gov/wood">www.p65warnings.ca.gov/wood</a> This product can expose you to chemicals, including formaldehyde, which are known to the State of California to cause cancer. For more information go to: <a href="http://www.p65warnings.ca.gov/furniture">www.p65warnings.ca.gov/furniture</a></p>		

**DESIGN SUBJECT TO CHANGE WITHOUT NOTICE.**

## CUSTOMER SERVICE

If you ever have questions about your furniture, please do not hesitate to contact us. In the unlikely event you need a replacement part; we can make those parts available through an authorized Whittier Wood Furniture dealer. If you cannot order replacement parts through your dealer, please contact our customer service department.

**Hours:** Our friendly customer service staff can be reached:

**Monday-Friday 8:00 a.m. to 5:00 p.m. (Pacific Time).**

You may leave a message 24 hours a day, seven days a week.

**Customer Service:** 800-653-3336 • **Outside the U.S.:** 541-687-0213

**Fax:** 541-687-2060 • **Email:** [info@whittierwood.com](mailto:info@whittierwood.com)





P.O. Box 2827  
Eugene, OR 97402 USA

Production Code :
VN <span style="float: right;">02/26</span>











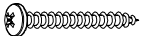

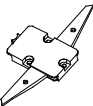







**1121j McKenzie 5-Drawer Lingerie Chest**  
**1129g McKenzie 5-Drawer Tall Chest**  
**1180i McKenzie 6-Drawer Chest**  
*Parts List*

Please identify the parts and check that quantities received match those on this list.  
If you need to replace a part, refer to the following letter and part name.

Part		Description	Quantity		
			1121GACf 1121JAVf 1121FSTf 1121PECf 1121SNf	1129GACg 1129JAVg 1129FSTg 1129PECg 1129SNg	1180GACi 1180JAVi 1180FSTi 1180PECi 1180SNi
A	11218001 (1121) 11298001 (1129) 11808001 (1180)	Top Assembly (attached)	1	1	1
Bh		Case	1	1	1
Fh	11014401 (1121) 11284401 (1129) 11264401 (1180)	Small Drawer Box (inserted)	3	2	2
Gh	11284411 (1129) 11264411 (1180)	Medium Drawer Box (inserted)	0	1	2
Hh	11214401 (1121) 11284421 (1129) 11264421 (1180)	Large Drawer Box (inserted)	2	2	2
I	11014001 (1121) 11284001 (1129) 11264001 (1180)	Small Drawer Face (attached)	3	2	2
J	11294011 (1129) 11264011 (1180)	Medium Drawer Face (attached)	0	1	2
K	11214021 (1121) 11294021 (1129) 11264021 (1180)	Large Drawer Face (attached)	2	2	2
L	9507481	Lg. Tuscan Bronze Knob (attached) 	5 (GAC)	8 (GAC)	10 (GAC)
	9508472	Lg. Antiqued Pewter Knob (attached) 	5 (JAV/FST/ PEC/SN)	8 (JAV/FST/ PEC/SN)	10 (JAV/FST/ PEC/SN)



**1121j McKenzie 5-Drawer Lingerie Chest  
1129g McKenzie 5-Drawer Tall Chest  
1180i McKenzie 6-Drawer Chest**

*Parts List*

Part		Description	Quantity		
			1121GACf 1121JAVf 1121FSTf 1121PECf 1121SNf	1129GACg 1129JAVg 1129FSTg 1129PECg 1129SNg	1180GACi 1180JAVi 1180FSTi 1180PECi 1180SNI
U	9502321	#8 x 1-1/4" Pan Head Screw (inserted) 	3	8	8
YD	9502811	#8 x 1-1/2" Machine Screw Tuscan (installed) 	5	8	10
YE	9502331	#8 x 7/8" Black Lo-Profile Screw (inserted) 	20	26	32
YF	9500181	Anti-Tip Snapper (attached) 	2	2	2
YG	9500191	Drawer Clip (attached) 	4	4	4
YH	9508864	Slotted Leveler (installed) 	4	4	4
YI	9509132	Leveler Adjustment Key (attached to Owners Manual) 	1	1	1
YJ	9500261	Linkage Arm (attached) 	2	2	2
YK	9501357	Aluminum Support Bar (attached) 	1	0	1
	9501358	Aluminum Support Bar (attached) 	0	1	0
YL	9502141	#6 x 5/8" Philtruss Screw (inserted) 	6	6	6
YM	9502381	#8 x 1-1/4" Black Screw (inserted) 	12	15	1
YN	9506181	1/4" Hex Nut (inserted) 	2	2	2
YO	9506211	1/4" T-Nut (inserted) 	8	8	12
YQ	9506463	1/4" x 25mm Hex Bolt (inserted) 	0	4	12
YR	9506465	1/4" x 18mm Hex Bolt (inserted) 	2	2	2
YT	9506063	Washer (inserted) 	2	2	2
YU	9501588	12" Drawer Slides (pre-installed sets) 	0	0	2
Za	9501583	14" Drawer Slides (pre-installed sets) 	5	5	4
ZB	9502122	#6 x 1/2" Philtruss Screw (inserted) 	42	42	48
ZC	9501841	#6 x 3/4" Philtruss Screw (inserted) 	36	36	42

**1121j McKenzie 5-Drawer Lingerie Chest  
1129g McKenzie 5-Drawer Tall Chest  
1180i McKenzie 6-Drawer Chest**

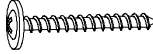
*Parts List*

Part	Description	Quantity		
		1121GACf 1121JAVf 1121FSTf 1121PECf 1121SNf	1129GACg 1129JAVg 1129FSTg 1129PECg 1129SNg	1180GACi 1180JAVi 1180FSTi 1180PECi 1180SNI
ZR	9506501 1/4" x 20mm Insert Nut (inserted) 	4	4	4
ZU	9502261 #8 x 1-3/8" Lo-Profile Screw (inserted) 	7	8	8
ZV	9506466 1/4" x 1-3/4" Hex Bolt (inserted) 	8	4	0
TS	9510005 Furniture Tipping Restraint (attached)	1 set	1 set	1 set

*1180 shown in the illustrations.*

**1121j McKenzie 5-Drawer Lingerie Chest**  
**1129g McKenzie 5-Drawer Tall Chest**  
**1180i McKenzie 6-Drawer Chest**  
*Assembly Instructions*

---

**Tools Required: Phillips Screwdriver, Pencil.**

**Tool Provided: Leveler Adjustment Key in the Zip bag taped to the Owner's Manual and Safety Guide.**

1. Place the unit at its final destination. Use the Leveler Adjustment Key (YI), found in the Zip bag taped to the Owner's Manual and Safety Guide to rotate the Slotted Levelers (YH) on the bottoms of the legs until the unit is level. See Figures 1 and 1a.

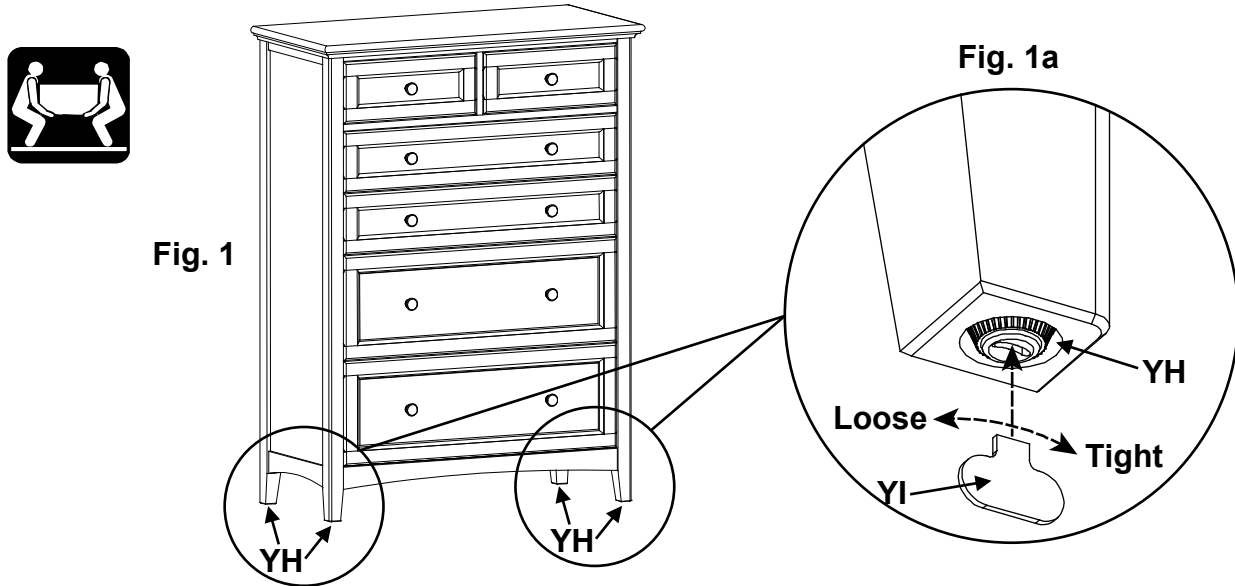

2. If you need to remove your drawers, pull up on the left Drawer Release Lever while pushing down on the right Drawer Release Lever and pull out the drawer. See Figures 2 and 2a. Note where each drawer came from to make sure you place them back into their correct positions.

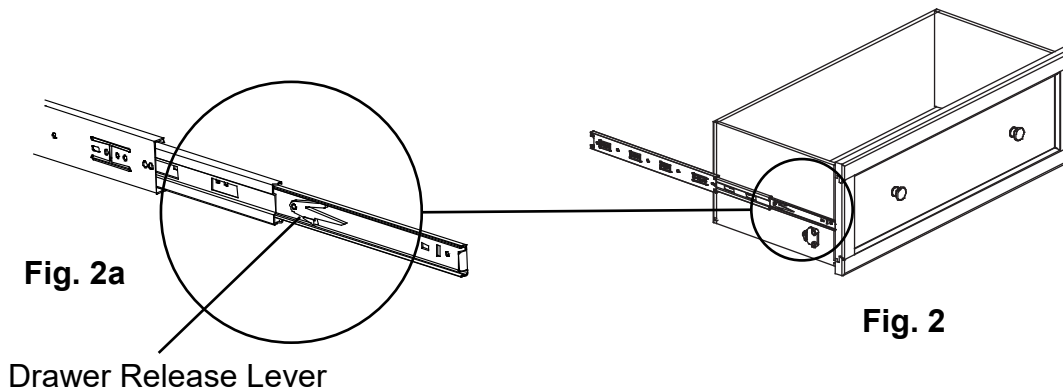

**1121j McKenzie 5-Drawer Lingerie Chest**  
**1129g McKenzie 5-Drawer Tall Chest**  
**1180i McKenzie 6-Drawer Chest**  
*Assembly Instructions*

---

3. This piece of furniture includes a drawer interlock system allowing only one lower drawer to be open at a time. This is a safety feature to reduce the risk of tip over. Do not defeat or remove the drawer interlock system.
4. When removing drawers from furniture featuring the Anti-Tip Drawer Interlock System it is important that the drawer be installed in its original location. Numbers and letters are stamped on the back of the drawers. Stamping sequence starts at the bottom, moves to the top and designated left or right.

Drawer back stamping example:

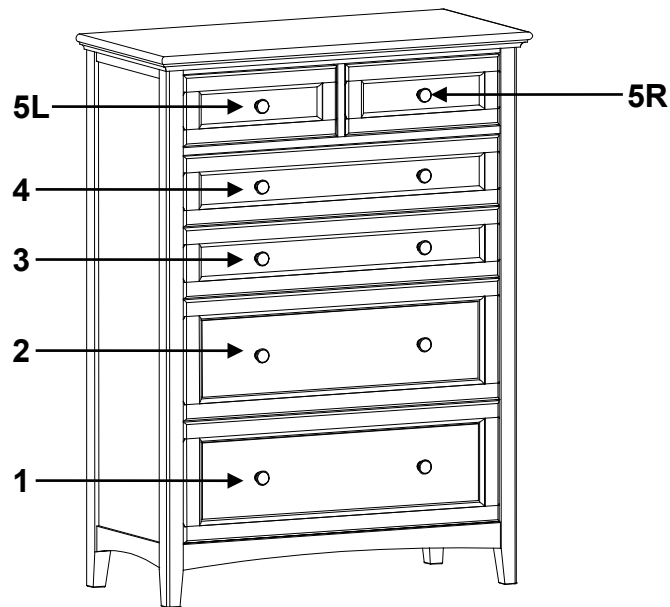

**Fig. 4**

*Continued on Page 6*

**1121j McKenzie 5-Drawer Lingerie Chest**  
**1129g McKenzie 5-Drawer Tall Chest**  
**1180i McKenzie 6-Drawer Chest**  
*Assembly Instructions*

---

5. Example; if you want to remove the First Drawer and Second Drawer from the chest; remove the Second Drawer first. When you remove this drawer the upper arm on the Anti-Tip Snapper for that side will be pulled forward. See Fig. 5d. As long as this arm is angled toward the front of the case, you cannot remove the First Drawer. Move the upper arms of the Anti-tip Snapper to the unlocked position as shown in Figure 5e. You can then remove the First Drawer as shown in Step 2. To reinstall the drawers, install the First Drawer then move the upper arm of the Anti-tip Snapper to the forward locked position. Now you can reinstall the Second Drawer.

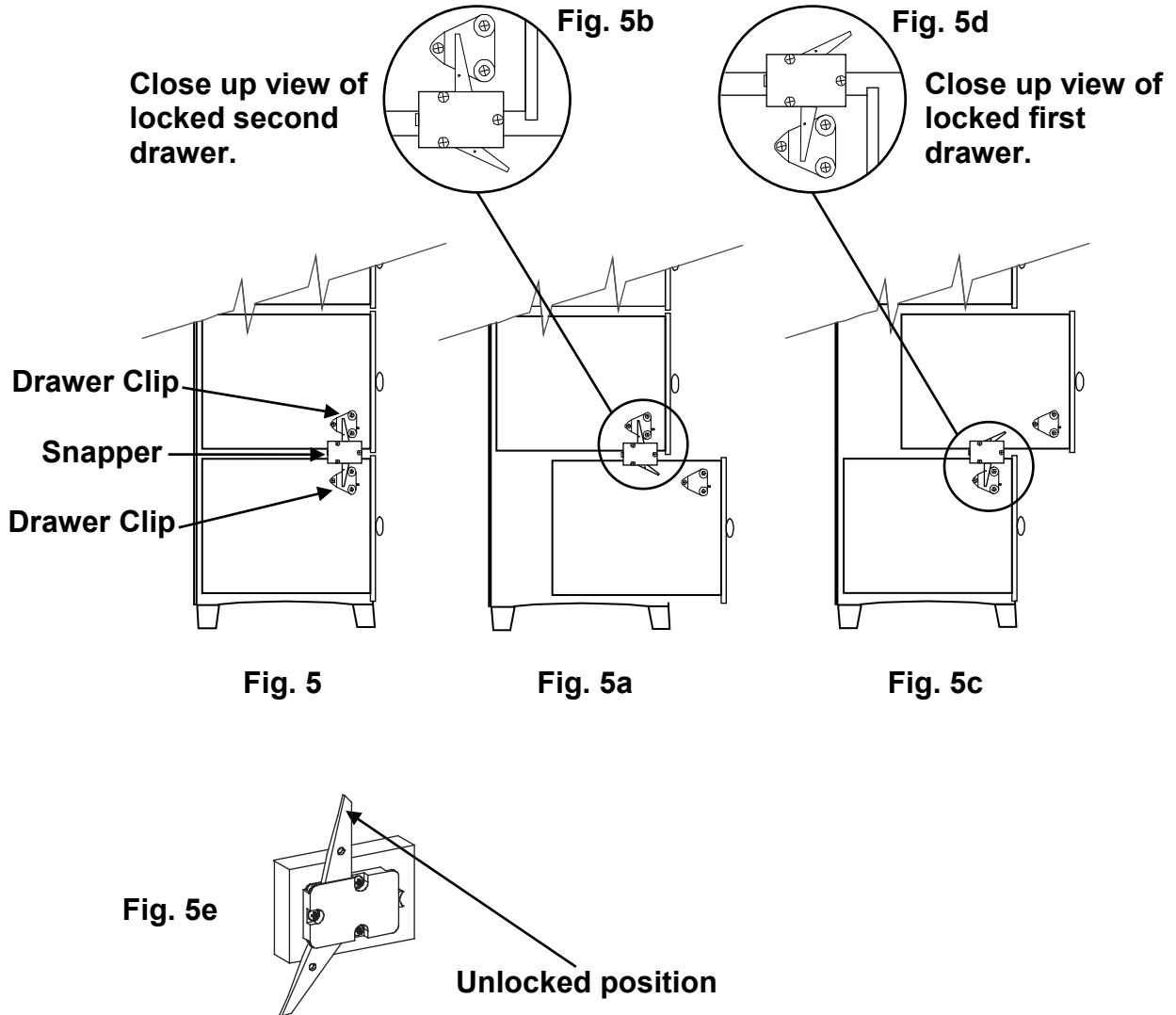





*Continued on Page 7*

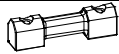

**1121j McKenzie 5-Drawer Lingerie Chest**  
**1129g McKenzie 5-Drawer Tall Chest**  
**1180i McKenzie 6-Drawer Chest**  
*Assembly Instructions*

## Furniture Tipping Restraint Instructions

# **Safety First! Anchor It!**

Before you begin this assembly, identify each part and make sure the quantities received match what is on this list. If you need to replace a part, contact Whittier Wood Furniture customer service and refer to the following list for its name and letter code.

Part	Description	Quantity
A	Cam Buckle and Short Strap (installed) 	1
B	Plastic Bracket (installed) 	1
C	1" x 1000mm Long Strap (installed) 	1
D	#8 x 3" Pan Head Screw 	2
E	#10 x 1" Oval Head Screw (inserted) 	1
F	Washer 	1

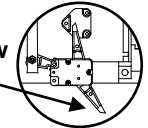
 <b>WARNING</b>		
	<p><b>Children have died from furniture tipover. To reduce the risk of furniture tipover:</b></p> <ul style="list-style-type: none"> <li>• ALWAYS install Anti-tip device provided.</li> <li>• NEVER put a TV on this product.</li> <li>• NEVER allow children to stand, climb or hang on any drawers, doors or shelves.</li> </ul>	<p>DO NOT remove the interlock system except for maintenance as shown. NEVER use the unit without the interlock installed following the instructions.</p>
	<ul style="list-style-type: none"> <li>• NEVER open more than one drawer at a time.</li> <li>• DO NOT defeat or remove the drawer interlock system; it is an important stability and safety system.</li> <li>• Place heaviest items in the lowest drawers.</li> </ul>	<p>The snapper arm must be angled forward in the locked positions to engage the interlock system after removing a drawer. See diagram below.</p> <p align="right">  </p>

**1121j McKenzie 5-Drawer Lingerie Chest  
 1129g McKenzie 5-Drawer Tall Chest  
 1180i McKenzie 6-Drawer Chest  
 Assembly Instructions**

**If you have a stone or tile floor or do not wish to drive screws into the corner of the baseboard and floor see the instruction included inside the tipping restraint kit for an alternate installation.**

- Decide where you want to place the piece of furniture in your room. Mark the baseboard with a pencil mark directly behind the location where the tipping restraint is attached to your item. Move the item away from the wall far enough to allow you to access the spot where the baseboard meets the floor. Position the straps and Plastic Bracket (B) as shown in Figures 6 and 6a with the angled corners of the Plastic Bracket (B) firmly placed against the seam of the baseboard and floor. Attach by driving #8 x 3" Pan Head Screws (D) through the holes in the Plastic Bracket (B) into the seam below the baseboard where it meets the floor. See Figures 6 and 6a.

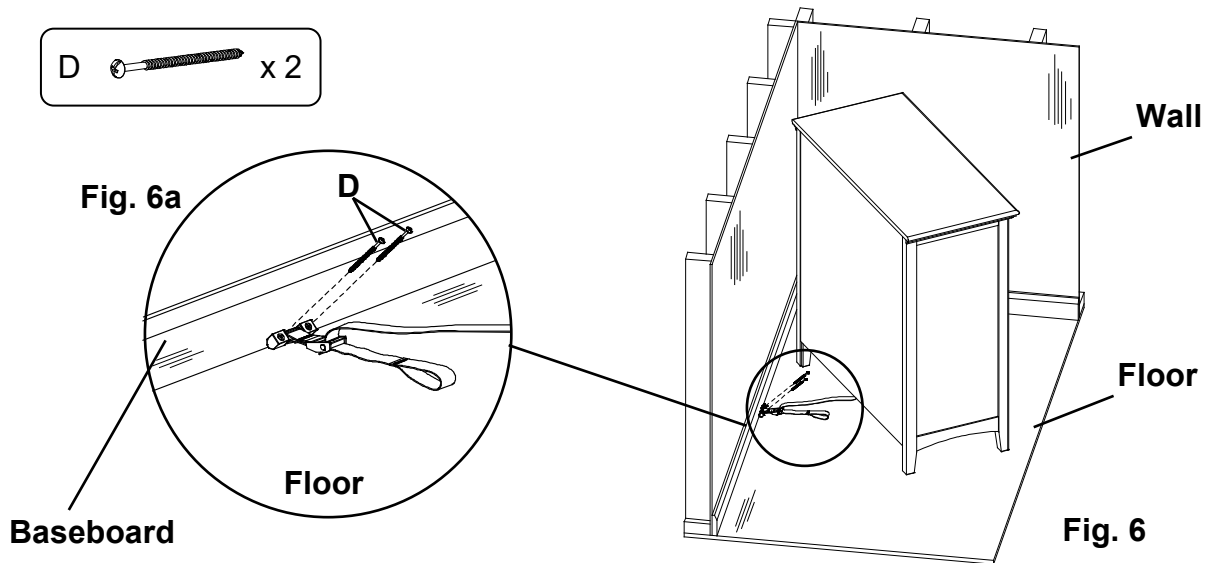

- Move the item back into position against the wall and reach underneath the piece of furniture to grasp the loop in the free end of the strap. Pull the free end of the strap until portion between the Cam Buckle (A) and the back apron of the item is tight. See Figures 7 and 7a. If you need to move the piece of furniture reach beneath and locate the buckle which connects the two sections of the strap and depress the release lever, then pull on the section of strap that is between the buckle and the back apron of the furniture until there is enough slack to allow you to pull the item away from the wall.

