

Model #

# 3501d

## McKenzie End Table

**GAC = Glazed Antique Cherry finish**

**JAV = Java finish**

**PEC = Pecan finish**

*Assembly Instructions*



*Thank you for allowing us to help you furnish your home. We are certain you will be delighted with your new furniture for many years to come.*

### IMPORTANT NOTES:

- For normal household use only. *Not* recommended for commercial use.
- Do not climb, sit or stand on this piece of furniture.
- Unload items before you move this unit.
- Do not overload the drawers.

### WARNING

Drilling, sawing, sanding or machining wood products can expose you to wood dust, a substance known to the state of California to cause cancer. Avoid inhaling wood dust or use a dust mask or other safeguards for personal protection.

For more information go to: [www.p65warnings.ca.gov/wood](http://www.p65warnings.ca.gov/wood)

This product can expose you to chemicals, including formaldehyde, which are known to the State of California to cause cancer.

For more information go to: [www.p65warnings.ca.gov/furniture](http://www.p65warnings.ca.gov/furniture)

**DESIGN SUBJECT TO CHANGE WITHOUT NOTICE.**

### CUSTOMER SERVICE

If you ever have questions about your furniture, please do not hesitate to contact us. In the unlikely event you need a replacement part; we can make those parts available through an authorized Whittier Wood Furniture dealer. If you cannot order replacement parts through your dealer, please contact our customer service department.

**Hours:** Our friendly customer service staff can be reached:

**Monday-Friday 8:00 a.m. to 5:00 p.m. (Pacific Time).**

You may leave a message 24 hours a day, seven days a week.

**Customer Service: 800-653-3336 • Outside the U.S.: 541-687-0213**

**Fax: 541-687-2060 • Email: [info@whittierwood.com](mailto:info@whittierwood.com)**

**Whittier  
Wood**  
FURNITURE

P.O. Box 2827  
Eugene, OR 97402 USA

Production Code :











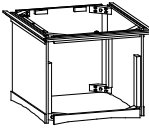
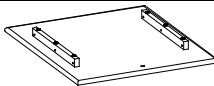
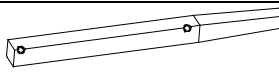
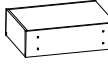

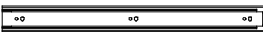

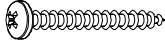

VN

09/23

## 3501d McKenzie End Table

### Parts List

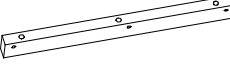
Please identify the parts and check that quantities received match those on this list.  
If you need to replace a part, refer to the following letter and part name.

Part	Description		Quantity
Ac	Case Assembly		1
Bc	Top Assembly(attached)		1
C	Leg		4
E	Drawer (inserted)		2
F	Drawer Face (installed)		2
G	20" Drawer Slides (pre-installed sets)		2
H	#6 x 3/4" Philtruss Screw (inserted)		12
I	#6 x 1/2" Philtruss Screw (inserted)		12
J	Knob (attached)		2
Kb	#8 x 1-1/2" Machine Screw Tuscan (installed)		2
N	#8 x 1-1/4" Pan Head Screw (inserted)		40
Ob	#8 x 7/8" Black Lo-Profile Screw (inserted)		8
P	3/8" x 1" Insert Nut (inserted)		8
Q	5/16" Flat Washer		8
R	3/8" x 2-1/2" Hex Bolt		8
S	1/4" x 20mm Insert Nut (inserted)		4
U	#8 x 1-3/8" Lo-Profile Screw (inserted)		2
V	#10 x 2" Pan Head Screw (inserted)		6
W	#8 Washer (inserted)		6
X	Top Support (attached)		2
Y	Slotted Leveler (installed)		4
ZA	Leveler Adjustment Key (attached to Owners Manual)		1

# 3501d McKenzie End Table

## Assembly Instructions

**Tools Required: Phillips Screwdriver, 9/16" or Adjustable Wrench**

**Tool Provided: Leveler Adjustment Key in the Zip bag taped to the Owner's Manual and Safety Guide.**

1. Remove the Drawers (E) from the Case Assembly (Ac). To remove the drawers, pull up on the left side of the Drawer Release Lever while pushing down on the right Drawer Release Lever. See Figure 1a. Note where each drawer came from to ensure correct installation.

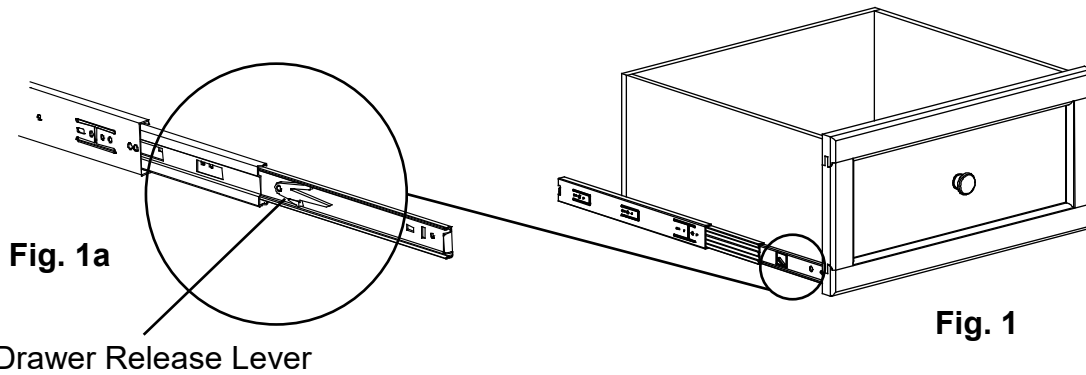

2. Turn the unit upside down on a clean, protected surface. Place two Legs (C) at the front corners of the Case Assembly (Ac) making sure the drilled corners of the legs face toward the Corner Blocks. Insert two 3/8" x 2-1/2" Hex Bolts (R) with two Flat Washers (Q) through the Corner Blocks and into the leg and fasten securely. See Figures 2 and 2a. Repeat for the other two legs.

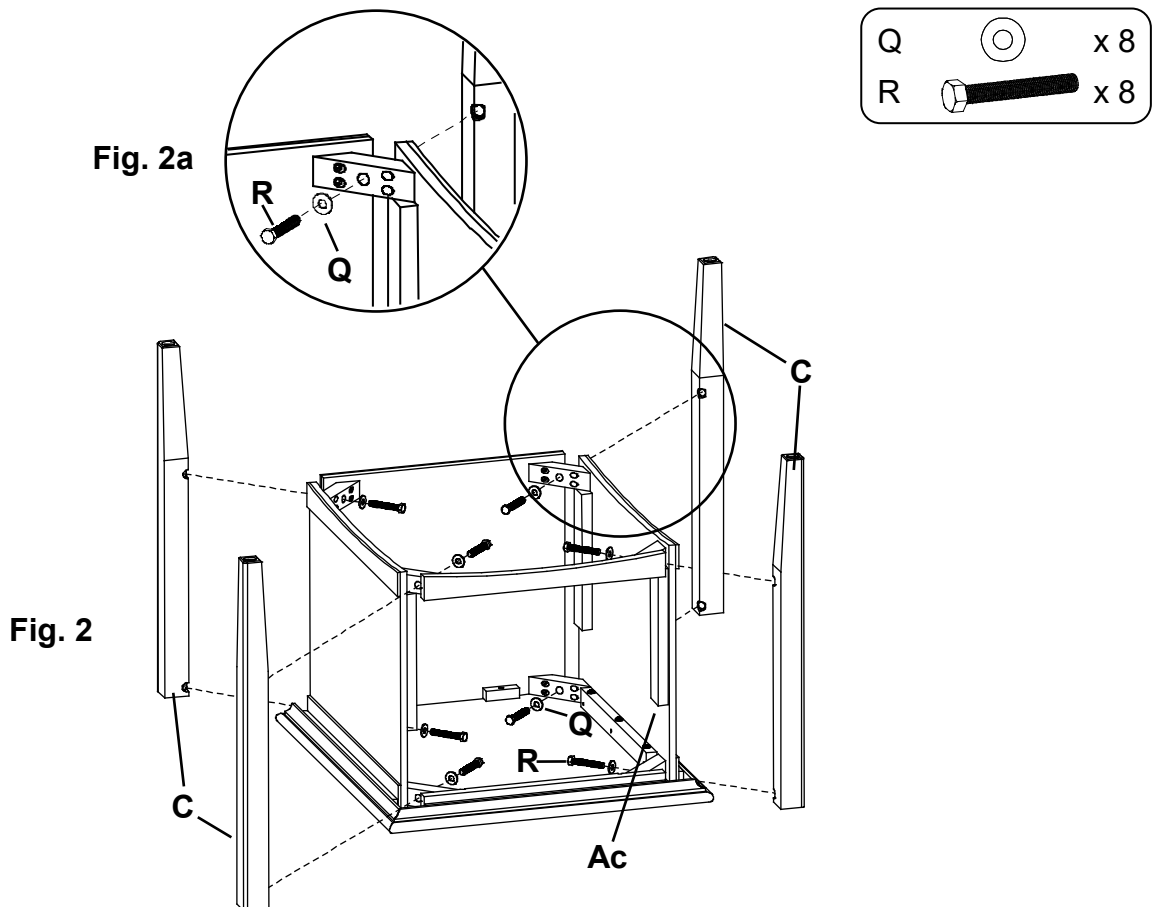

# 3501d McKenzie End Table

## Assembly Instructions

---

3. Turn the table upright and insert the Drawers (E).

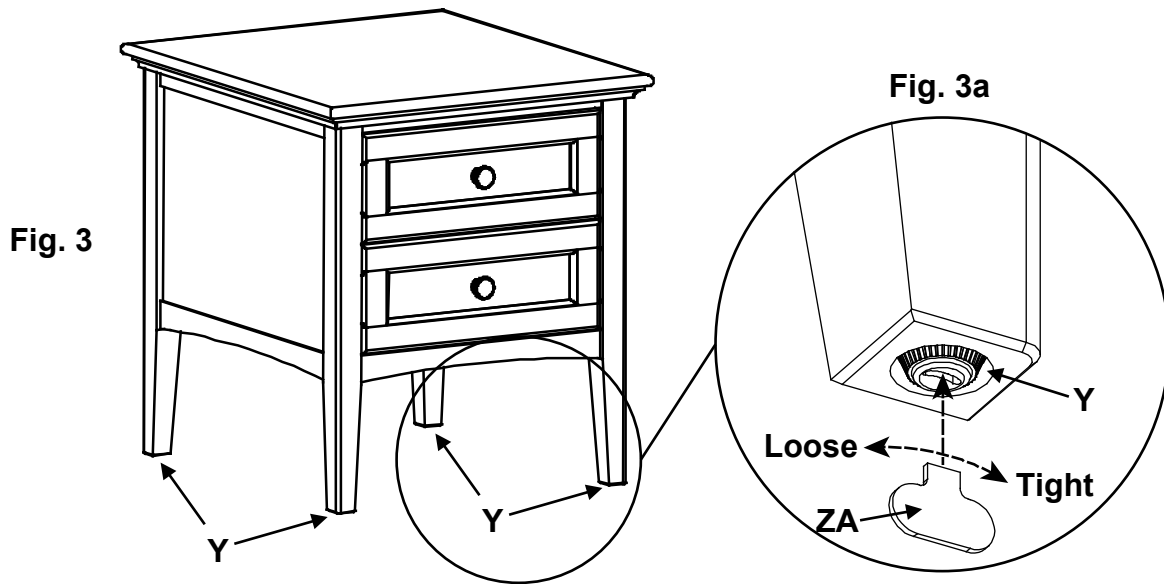

4. Place the table at its final destination. Use the Leveler Adjustment Key (ZA), found in the Zip bag taped to the Owner's Manual and Safety Guide to rotate the Slotted Levelers (Y) on the bottoms of the legs until the table is level. See Figures 3 and 3a.