

Ellison Nightstands

AST = Astoria Sky finish

Assembly Instructions

Model #

2115ASTb Ellison Small 3-Drawer Nightstand



2116ASTb Ellison 3-Drawer Nightstand



Thank you for allowing us to help you furnish your home. We are certain you will be delighted with your new furniture for many years to come.

IMPORTANT NOTES:

- For normal household use only. *Not* recommended for commercial use.
- Do not climb, sit or stand on this piece of furniture.
- Do not overload the drawers.
- Unload items before you move this unit.

WARNING

Drilling, sawing, sanding or machining wood products can expose you to wood dust, a substance known to the state of California to cause cancer. Avoid inhaling wood dust or use a dust mask or other safeguards for personal protection.

For more information go to: www.p65warnings.ca.gov/wood

This product can expose you to chemicals, including formaldehyde, which are known to the State of California to cause cancer.

For more information go to: www.p65warnings.ca.gov/furniture

DUAL PORT USB WALL CHARGER: CAUTION: Changes or modifications not approved by the party responsible for compliance could void user's authority to operate the equipment.

NOTE: This equipment has been tested and found to comply with the limits for a Class B digital device, pursuant to part 15 of the FCC Rules. These limits are designed to provide reasonable protection against harmful interference in a residential installation. This equipment generates, uses and can radiate radio frequency energy and, if not installed and used in accordance with the instructions, may cause harmful interference to radio communications. However, there is no guarantee that interference will not occur in a particular installation. If this equipment does cause harmful interference to radio or television reception, which can be determined by turning the equipment off and on, the use is encouraged to try to correct the interference by one or more of the following measures:

- Reorient or relocate the receiving antenna.
- Increase the separation between the equipment and receiver
- Connect the equipment into an outlet on a circuit different from that to which the receiver is connected.

Consult the dealer or an experienced radio/TV technician for help.

DESIGN SUBJECT TO CHANGE WITHOUT NOTICE.

CUSTOMER SERVICE

If you ever have questions about your furniture, please do not hesitate to contact us. In the unlikely event you need a replacement part; we can make those parts available through an authorized Whittier Wood Furniture dealer. If you cannot order replacement parts through your dealer, please contact our customer service department.

Hours: Our friendly customer service staff can be reached:

Monday-Friday 8:00 a.m. to 5:00 p.m. (Pacific Time).

You may leave a message 24 hours a day, seven days a week.

Customer Service: 800-653-3336 • Outside the U.S.: 541-687-0213

Fax: 541-687-2060 • Email: info@whittierwood.com

**Whittier
Wood**
FURNITURE

P.O. Box 2827
Eugene, OR 97402 USA



















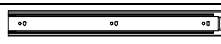

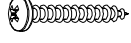
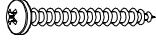

Production Code:

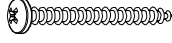
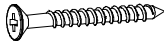
VN

09/23

2115ASTb Ellison Small 3-Drawer Nightstand
2116ASTb Ellison 3-Drawer Nightstand
Parts List

Please identify the parts and check that quantities received match those on this list.
 If you need to replace a part, refer to the following letter and part name.

Part	Description		Quantity	
			2115ASTb	2116ASTb
A	Top Assembly (attached)		1	1
B	Case		1	1
C	Small Drawer Box (inserted)		1	1
D	Medium Drawer Box (inserted)		1	1
E	Large Drawer Box (inserted)		1	1
F	Small Drawer Face (installed)		1	1
G	Medium Drawer Face (installed)		1	1
H	Large Drawer Face (installed)		1	1
I	Base (attached)		1	1
J	Drawer Slides (pre-installed sets)		3	3
K	#6 x 3/4" Philtruss Screw (inserted)		18	18
L	#6 x 1/2" Philtruss Screw (inserted)		18	18
N	#8 x 1-3/8" Lo-Profile Screw (inserted)		10	12
O	#8 x 1" Pan Head Screw (inserted)		6	6
P	#8 x 1-1/4" Pan Head Screw (inserted)		6	6
Q	#8 x 7/8" Black Lo-Profile Screw (inserted)		21	22
R	#8 x 1-3/4" Pan Head Screw (inserted)		8	8
S	#8 x 1-5/8" Black Screw (inserted)		8	8
T	#8 x 1-5/8" Machine Screw Tuscan (installed)		6	6
U	1/4" x 20mm Insert Nut (inserted)		4	4
V	Antique Pewter Pull (attached)		3	3
X	Slotted Leveler (installed)		4	4
Y	Leveler Adjustment Key (attached to Owners Manual)		1	1
ZA	Power Supply (attached)		1	1
ZB	A/C Dual Port (attached)		1	1
ZC	#6 x 5/8" Philtruss Screw (inserted)		2	2

2116 shown in the illustrations.

2115ASTb Ellison Small 3-Drawer Nightstand
2116ASTb Ellison 3-Drawer Nightstand
Assembly Instructions

Tool Required: Phillips Screwdriver.

Tool Provided: Leveler Adjustment Key in the Zip bag taped to the Owner's Manual and Safety Guide.

1. Remove screws from the plywood supports and side aprons. Recycle or discard. See Figure 1.

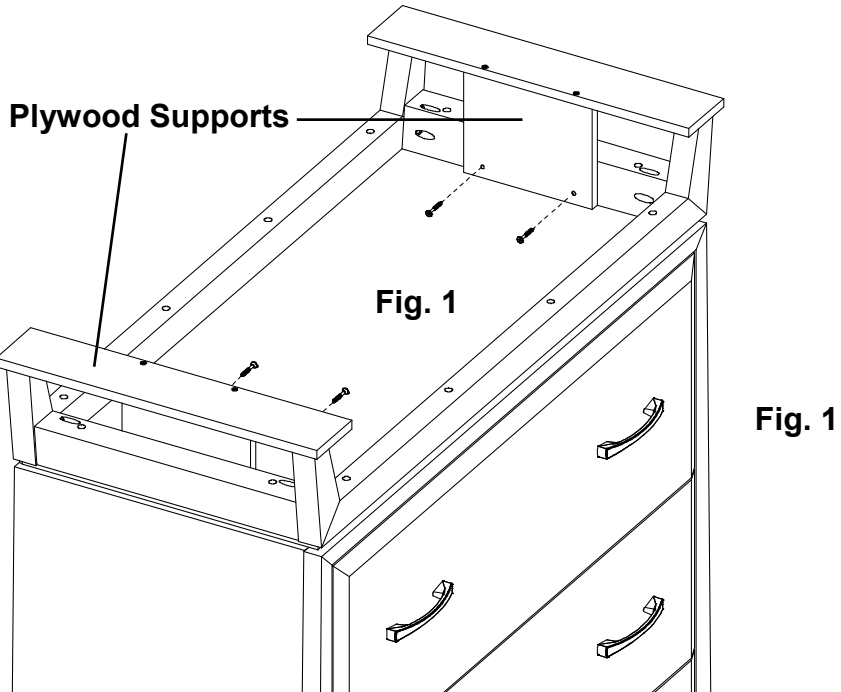

2. Place the unit at its final destination. Use the Leveler Adjustment Key (Y), found in the Zip bag taped to the Owner's Manual and Safety Guide to rotate the Slotted Levelers (X) on the bottoms of the legs until the unit is level. See Figures 2 and 2a.

