

# Center Wall Unit Finished Program

Assembly Instructions

Model #

**1610d**

**Center Wall Unit**

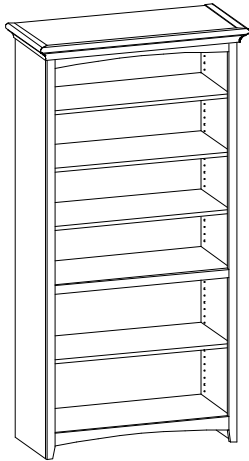

**1611d**

**Center Wall Unit  
with doors**

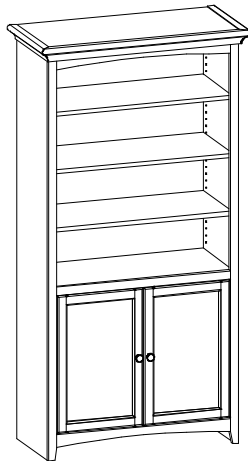

*Thank you for allowing us to help you furnish your home.  
We are certain you will be delighted with your new furniture  
for many years to come.*

## IMPORTANT NOTES:

- This assembly requires two people.
- For normal household use only. *Not* recommended for commercial use.
- Do not climb, sit or stand on this piece of furniture.
- Unload items before you move this unit.
- Do not overload the shelves on this unit.
- Before loading or moving this unit, check all screws and supports for tightness.
- For maximum stability, attach unit to the wall using the enclosed hardware as per instructions.
- Before you begin your project, completely read the Assembly Instructions.
- Periodically inspect your furniture for any loose glue joints, screws or any other problem that might affect the stability of your furniture. Tighten or repair as needed.

## **WARNING**

**Children have died from furniture tipover. To reduce the risk of furniture tipover:**

- ALWAYS install Anti-tip device provided.
- NEVER put a TV on this product.
- NEVER allow children to stand, climb or hang on doors, or shelves.
- Place heaviest items on the bottom shelves.

**Use of tipover restraints may only reduce, but not eliminate, the risk of tipover.**

**Attention:** Attached to the bottom of or included with this unit is a tipping restraint kit. When you receive your furniture, be sure to find and install the tipping restraint as instructed in the kit. If you cannot locate the restraint, please contact customer service immediately for a replacement.

Drilling, sawing, sanding or machining wood products can expose you to wood dust, a substance known to the state of California to cause cancer. Avoid inhaling wood dust or use a dust mask or other safeguards for personal protection.

For more information go to: [www.p65warnings.ca.gov/wood](http://www.p65warnings.ca.gov/wood)

This product can expose you to chemicals, including formaldehyde, which are known to the State of California to cause cancer.

For more information go to: [www.p65warnings.ca.gov/furniture](http://www.p65warnings.ca.gov/furniture)

**DESIGN SUBJECT TO CHANGE WITHOUT NOTICE.**

## CUSTOMER SERVICE

If you ever have questions about your furniture, please do not hesitate to contact us. In the unlikely event you need a replacement part; we can make those parts available through an authorized Whittier Wood Furniture dealer. If you cannot order replacement parts through your dealer, please contact our customer service department.

**Hours:** Our friendly customer service staff can be reached:

**Monday-Friday 8:00 a.m. to 5:00 p.m. (Pacific Time).**

You may leave a message 24 hours a day, seven days a week.

**Customer Service: 800-653-3336 • Outside the U.S.: 541-687-0213**

**Fax: 541-687-2060 • Email: [info@whittierwood.com](mailto:info@whittierwood.com)**

**Whittier  
Wood**  
FURNITURE

P.O. Box 2827  
Eugene, OR 97402 USA

Production Code:

# 1610d Center Wall Unit & 1611d Center Wall Unit with doors

## Parts List

Before you begin to assemble this unit, identify each part and make sure the quantities received match what is on this list.

If you need to replace a part, please refer to the following list for the finish, part name and letter code.

### Bookcase Finish

Please note the finish of the bookcase for replacement part orders.

Bookcase finish options are subject to change.

#### Stain

<b>GAC</b>	Glazed Antique Cherry	<b>JAV</b>	Java	<b>FST</b>	Fieldstone	<b>HAZ</b>	Hazelnut	<b>NA</b>	Natural Alder	<b>PEC</b>	Pecan
------------	-----------------------	------------	------	------------	------------	------------	----------	-----------	---------------	------------	-------

#### Paint













<b>SN</b>	Snowbound SW 7004
-----------	----------------------

<b>TB</b>	Tricorn Black SW 6258
-----------	--------------------------

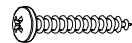
#### Two-Tone

<b>SNN</b>	Snowbound SW 7004 Natural Alder
------------	---------------------------------------

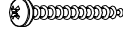
<b>TBN</b>	Tricorn Black SW 6258 Natural Alder
------------	-------------------------------------------

Part	Description	Quantity	
		1610d	1611d
A	Top (attached) 	1	1
B	Adjustable Shelf (attached) 	4	4
C	Door (attached) 	0	2
D	Shelf Bracket (installed) 	16	16
E	#6 x 1/2" Undercut Screw (inserted) 	16	16
F	Knob (attached) 	0	2
Ga	#8 x 1-1/2" Machine Screw Tuscan (installed) 	0	2
H	#8 x 1" Pan Head Screw (inserted) 	10	10
I	Nylon Insert (inserted) 	4	4
Kd	Soft Close Hinge #659BD (attached) 	0	4
Ld	Hinge Plate (attached) 	0	4
M	Hex Bumper (attached) 	0	2
N	#8 x 1-1/4" Pan Head Screw (inserted) 	29	29
TB	Bookcase Tipping Restraint	1	1
U	Slotted Leveler (installed) 	4	4
Ua	Leveler Adjustment Key (attached to Owner's Manual) 	1	1

*1611 shown in the illustrations.*

# 1610d Center Wall Unit & 1611d Center Wall Unit with doors *Assembly Instructions*

**Tools Required: Phillips Screwdriver, Pencil, Rubber Mallet or Padded Hammer.**  
**Tools Provided: Leveler Adjustment Key in the Zip bag to the Owner's Manual and Safety Guide.**

**1. To move the adjustable shelves:**

Determine where you want to place the Adjustable Shelves (B). Remove the #6 x 1/2" Undercut Screws (E) from the underside of the shelf and take out the Shelf and Shelf Brackets (D). Insert the Shelf Brackets (flat side down) into the four different holes and insert the shelf. You may secure them by inserting #6 x 1/2" Undercut Screws (E). See Figures 1 and 1a.

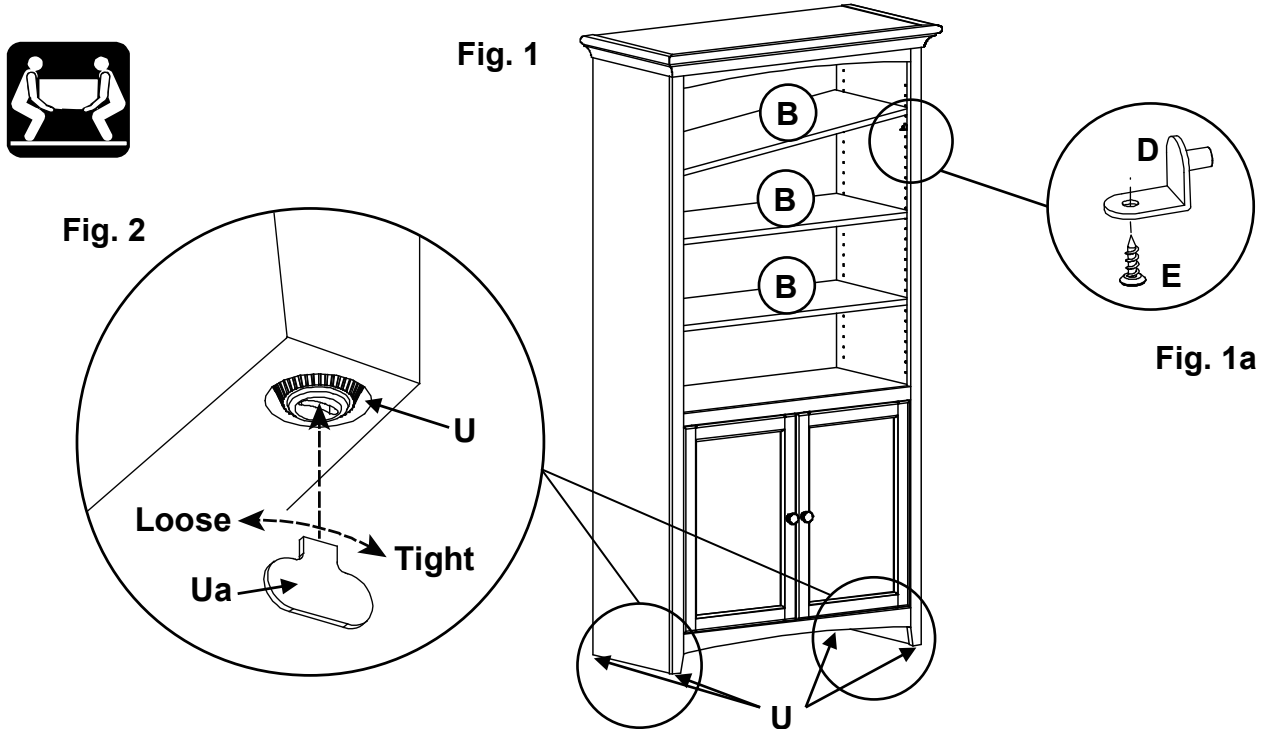

**2. Place the unit at its final destination. Use the Level Adjustment Key (Ua), found in the Zip bag taped to the Owner's Manual and Safety Guide to rotate the Slotted Levelers (U) on the bottoms of the legs until the unit is level. See Figures 1 and 2.**

**3. To adjust the doors, follow the instructions below.**

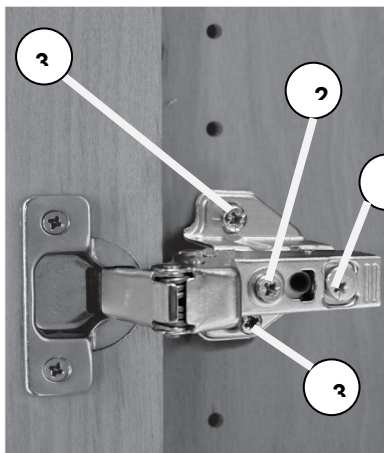

**Fig. 3**

**Side adjustment**

To move the door towards the side panel, rotate screw '2' counter-clockwise. To move the door away from the side panel, rotate screw '2' clockwise.

**Depth Adjustment**

Loosen screw '1' and adjust the door. Re-tighten screw.

**Height Adjustment**





Loosen screws '3' and adjust the door. Re-tighten screw.

If there is a problem with the Soft Close hinges (Kd), do not attempt to remove it. Contact Customer Service first.

**1610d Center Wall Unit &  
1611d Center Wall Unit with doors**  
*Assembly Instructions*

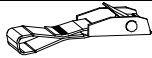
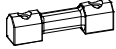
# Bookcase Tipping Restraint Instructions

Before you begin this assembly, identify each part and make sure the quantities received match what is on this list. If you need to replace a part, contact Whittier Wood Furniture customer service and refer to the following list for its name and letter code.

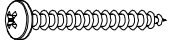
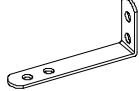
Part	Description		Quantity
A	Cam Buckle and Short Strap (installed)		1
B p	Plastic Bracket (installed)		1
C	1" x 1000mm Long Strap (installed)		1
D	#8 x 3" Pan Head Screw		2
F	Washer (installed)		1
G	#8 x 5/8" Pan Head Screw		1
H	#8 x 1-1/4" Pan Head Screw		2 (1 inserted)
I	"L" Angle Bracket		1

**If you have a stone or tile floor or do not wish to drive screws into the corner of the baseboard and floor see the instruction included inside the tipping restraint kit for an alternate installation.**

*Continued on Page 5*

# 1610d Center Wall Unit & 1611d Center Wall Unit with doors

## Assembly Instructions

- Decide where you want to place the bookcase in your room. Mark the baseboard with a pencil mark directly behind the location where the tipping restraint is attached to your item. Move the item away from the wall far enough to allow you to access the spot where the baseboard meets the floor. Position the straps and Plastic Bracket (B) as shown in Figures 4 and 4a with the angled corners of the Plastic Bracket (B) firmly placed against the seam of the baseboard and floor. Attach by driving #8 x 3" Pan Head Screws (D) through the holes in the Plastic Bracket (B) into the seam below the baseboard where it meets the floor. See Figures 4 and 4a.

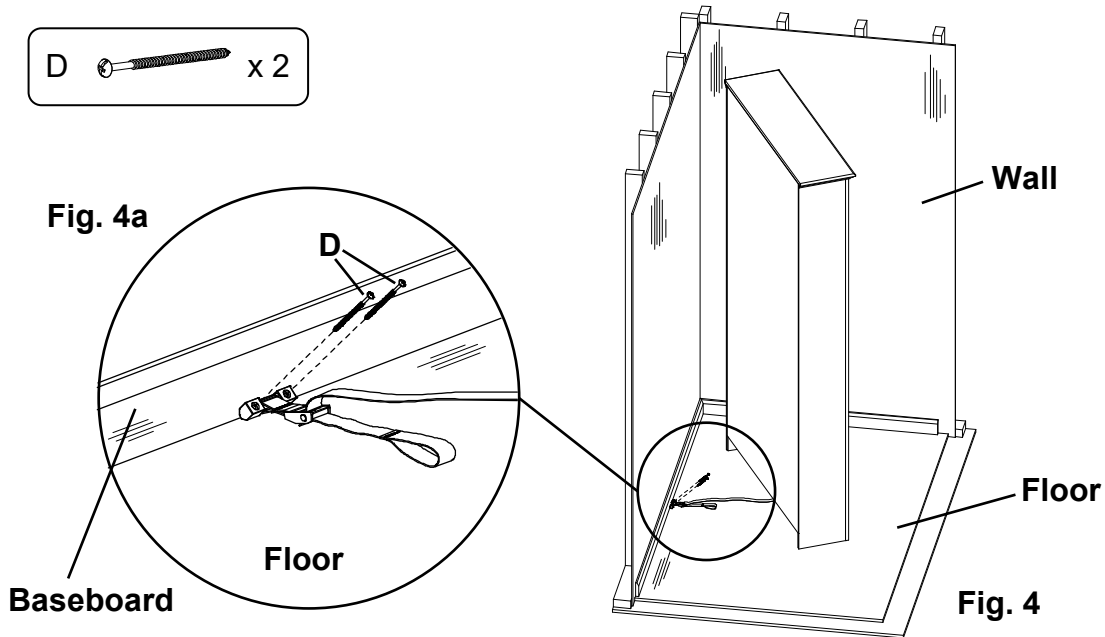

- Move the item back into position against the wall and reach underneath the bookcase to grasp the loop in the free end of the strap. Pull the free end of the strap until portion between the Cam Buckle (A) and the bottom of the item is tight. See Figures 5 and 5a. If you need to move the bookcase reach beneath and locate the buckle which connects the two sections of the strap and depress the release lever, then pull on the section of strap that is between the buckle and the bottom of the furniture until there is enough slack to allow you to pull the item away from the wall.

