

Model #

3838DUETa

Addison Queen Bookcase Storage Bed

DUET finish

Assembly Instructions

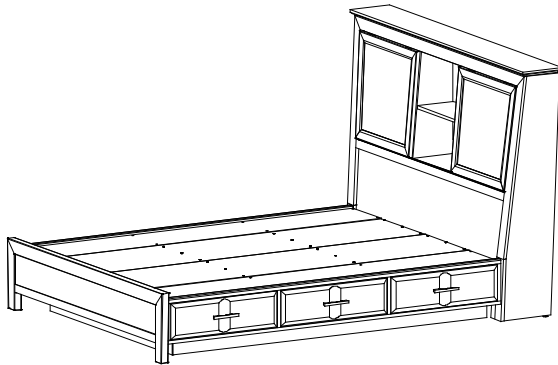

Thank you for allowing us to help you furnish your home. We are certain you will be delighted with your new furniture for many years to come.

IMPORTANT NOTES:

- Wood can be susceptible to changing color over time when exposed to strong sunlight. Use window shades, drapes or blinds to protect your furniture. To help the surface age evenly and avoid dark and light spots, periodically move items to expose the entire surface to an even amount of light so it may develop a uniform patina.
- For normal household use only. *Not* recommended for commercial use.
- Remove items before you move this unit.
- Do not overload the concealed storage areas.
- Use care when operating the soft-close sliding doors. Minimal effort is required for doors to perform.
- This assembly requires two people.

WARNING

Drilling, sawing, sanding or machining wood products can expose you to wood dust, a substance known to the state of California to cause cancer. Avoid inhaling wood dust or use a dust mask or other safeguards for personal protection.

For more information go to: www.p65warnings.ca.gov/wood

This product can expose you to chemicals, including formaldehyde, which are known to the State of California to cause cancer.

For more information go to: www.p65warnings.ca.gov/furniture

DUAL PORT USB WALL CHARGER: CAUTION: Changes or modifications not approved by the party responsible for compliance could void user's authority to operate the equipment .

NOTE: This equipment has been tested and found to comply with the limits for a Class B digital device, pursuant to part 15 of the FCC Rules. These limits are designed to provide reasonable protection against harmful interference in a residential installation. This equipment generates, uses and can radiate radio frequency energy and, if not installed and used in accordance with the instructions, may cause harmful interference to radio communications. However, there is no guarantee that interference will not occur in a particular installation. If this equipment does cause harmful interference to radio or television reception, which can be determined by turning the equipment off and on, the use is encouraged to try to correct the interference by one or more of the following measures:

- Reorient or relocate the receiving antenna.
- Increase the separation between the equipment and receiver
- Connect the equipment into an outlet on a circuit different from that to which the receiver is connected.

Consult the dealer or an experienced radio/TV technician for help.

DESIGN SUBJECT TO CHANGE WITHOUT NOTICE.

CUSTOMER SERVICE

If you ever have questions about your furniture, please do not hesitate to contact us. In the unlikely event you need a replacement part; we can make those parts available through an authorized Whittier Wood Furniture dealer. If you cannot order replacement parts through your dealer, please contact our customer service department.

Hours: Our friendly customer service staff can be reached:

Monday-Friday 8:00 a.m. to 5:00 p.m. (Pacific Time).

You may leave a message 24 hours a day, seven days a week.

Customer Service: 800-653-3336 • Outside the U.S.: 541-687-0213

Fax: 541-687-2060 • Email: info@whittierwood.com

**Whittier
Wood**
FURNITURE

P.O. Box 2827
Eugene, OR 97402 USA

Production Code:

VN











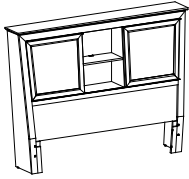
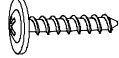

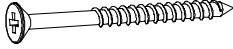







12/22

3838DUETa Addison Queen Bookcase Storage Bed



Parts List

Please identify the parts and check that quantities received match those on this list.
If you need to replace a part, refer to the following letter and part name.

3839DUETa Headboard Kit (x1)



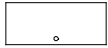

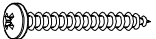
Part	Description		Quantity
Aa	Headboard Assembly		1
K	#8 x 7/8" Black Lo-Profile Screw (inserted)		14
M	#8 x 1-5/8" Black Screw (inserted)		4
Y	5/16" x 14mm Insert Nut (inserted)		4
YA	#8 x 2-1/4" Black Screw (inserted)		4
YB	60mm Long Strap (installed)		4
YC	#6 x 1/2" Undercut Screw AB (inserted)		8
YD	Washer (installed)		8
YE	#6 x 3/4" Flat Head Screw (inserted)		16
YF	#6 x 5/8" Undercut Screw ZN (inserted)		16
ZH	Short Aluminum Track Rail (installed)		1
ZI	Long Aluminum Track Rail (installed)		1
ZJ	Roller (installed)		8
ZK	Soft Close Damper (installed)		2
ZL	#8 x 5/8" Pan Head Screw (inserted)		8
ZM	#8 x 1-3/8" Lo-Profile Screw (inserted)		20
ZO	Power Supply (attached)		1
ZP	A/C Dual Port (attached)		1
ZQ	Corner Brace (attached)		2
ZR	Large Adjustable Glide (installed)		2
ZS	Tack Glide (attached)		4
ZT	Top Assembly (attached)		1
ZUa	Left Door (installed)		1

3838DUETa Addison Queen Bookcase Storage Bed
Parts List

Part	Description	Quantity
ZVa	Right Door (installed) 	1
ZW	False Bottom (installed) 	2
ZX	#6 x 5/8" Philtruss Screw (inserted) 	2
ZY	#8 x 1-1/4" Pan Head Screw (inserted) 	2

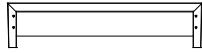
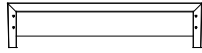
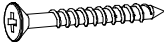

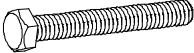
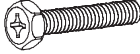





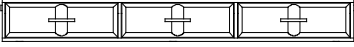
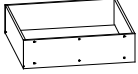
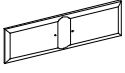

3838DUETa Addison Queen Bookcase Storage Bed
Parts List

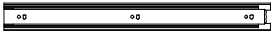
3840DUET Footboard Kit (x1)

Part	Description		Quantity
B	Footboard Assembly		1
L	#8 x 1-1/4" Black Screw		24
Y	5/16" x 14mm Insert Nut (inserted)		4
ZE	5/16" x 2-1/4" Hex Bolt		6
ZF	5/16" x 35mm Hex Bolt		18
ZG	1/4" Flat Washer		24









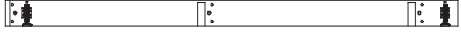

3838DUETa Addison Queen Bookcase Storage Bed
Parts List

2019DUET
Queen/King Pedestal Kit (x2)

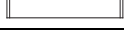
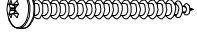
Part	Description	Quantity
D	Pedestal 	1
E	Drawer Box (assembled) 	3
F	Drawer Face (attached) 	3
G	Left/Right Center Deckboard 	1
H	20" Drawer Slides (installed) 	3 sets
I	#6 x 3/4" Philtruss Screw (inserted) 	18
J	#6 x 1/2" Philtruss Screw (inserted) 	18
K	#8 x 7/8" Black Lo-Profile Screw (inserted) 	18
L	#8 x 1-1/4" Black Screw (inserted) 	8
M	#8 x 1-5/8" Black Screw (inserted) 	24
N	#8 x 1-5/8" Machine Screw Tuscan (installed) 	6
O	5/32" x 10mm Insert Nut (inserted) 	6
P	Black Walnut Pull (attached) 	3

3838DUETa Addison Queen Bookcase Storage Bed
Parts List

2021DUET
Addison Queen Base Kit (x1)

Part	Description	Quantity
Q	Mitered End Support 	1
R	Square End Support 	2
S	Left Support 	1
T	Right Support 	1
U	Queen Trestle Rail (15-1/8") 	4
W	#8 x 1-3/4" Pan Head Screw (inserted) 	12
X	#10 x 3/4" Pan Head Screw (inserted) 	16
Y	5/16" x 14mm Insert Nut (inserted) 	18
ZA	Wood Dowel (inserted) 	12
ZB	Foot Bracket (attached) 	4
ZC	Adjustable Glide (installed) 	4

3838DUETa Addison Queen Bookcase Storage Bed

Assembly Instructions

This assembly requires two people.

Tools Required: Slotted screwdriver, Phillips screwdriver, 1/2" open end or box end wrench.

1. Lay out and identify the parts from the Queen (#2021) Base Kit. Set aside part Trestle Rail (U) for use later in the assembly process. Use the notch and dowels on Square End Support (R) and Mitered End Support (Q) as a guide attach to the Right Support (T) using the Hex Bolts (ZE) and Washers (ZG) from the Headboard/Footboard Kit. See Figures 1 and 1a.

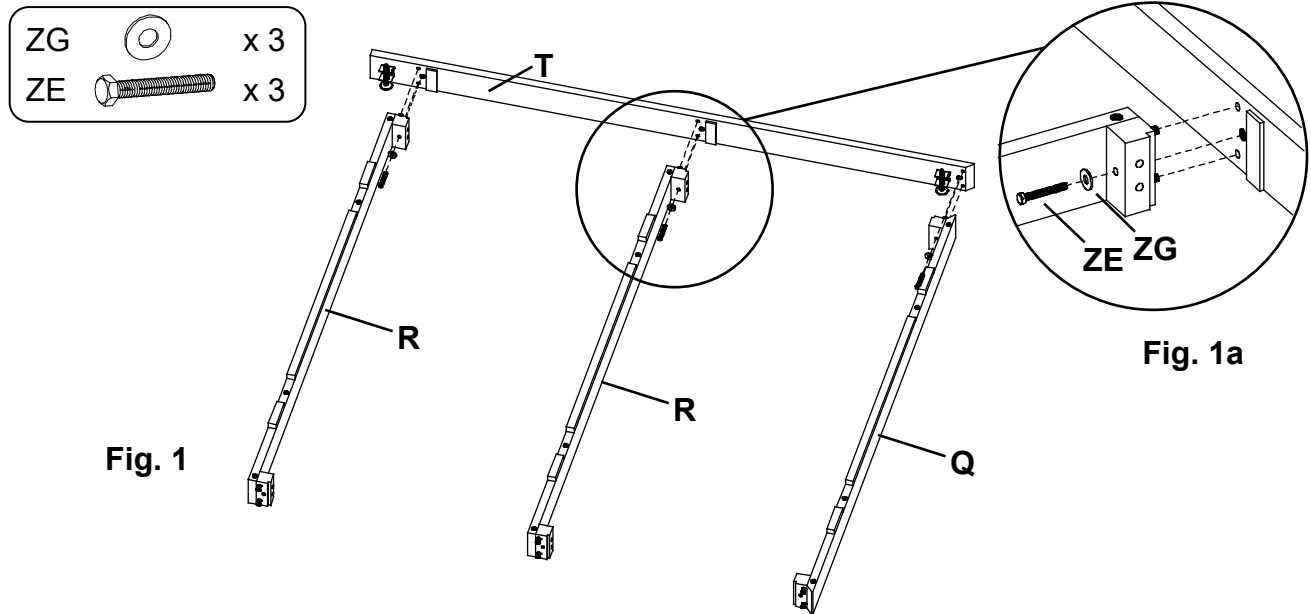

2. Attach the assembly to the Left Support (S) Using Hex Bolts (ZE) and Washers (ZG). See Figures 2 and 2a. Identify the Headboard end of the assembly and place near the final bed location. See drawing below.

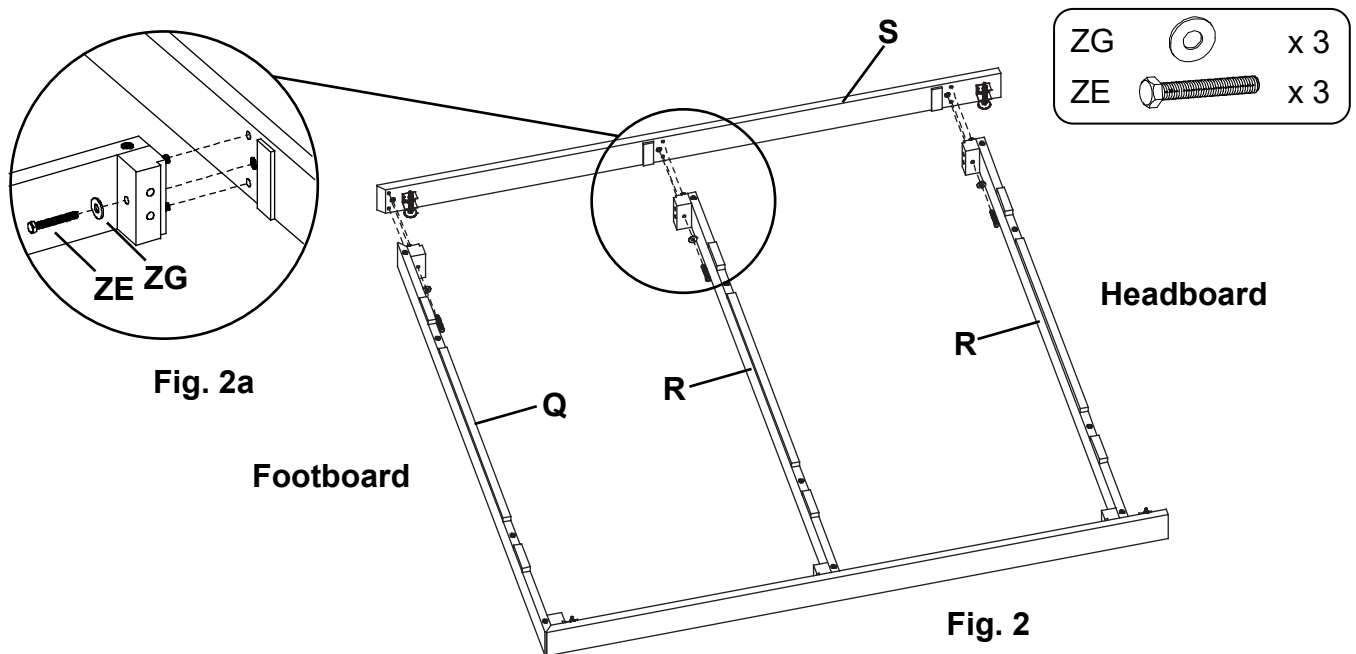

3838DUETa Addison Queen Bookcase Storage Bed

Assembly Instructions

This assembly requires two people.

- Place each pedestal (D) on top of the base kit against the side of and between the locator blocks of the Base Kit. See Figure 3.

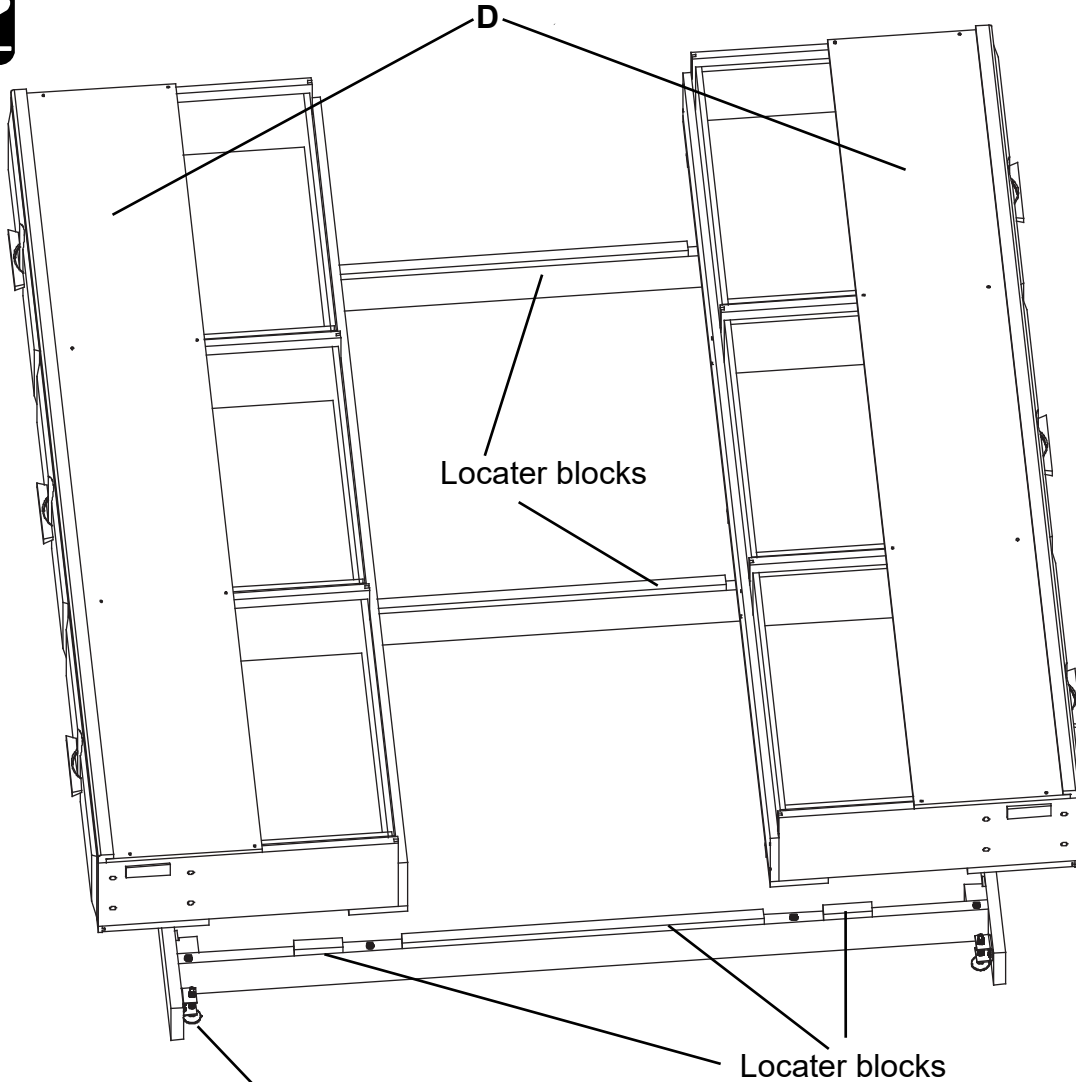

Fig. 3

Headboard end of Base has leveler outside the crosspiece

3838DUETa Addison Queen Bookcase Storage Bed

Assembly Instructions

This assembly requires two people.

4. Open the drawers and attach the pedestal to the base using Hex Bolts (ZF) and Washers (ZG) only finger tight. See Figures 4 and 4a.

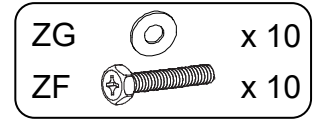
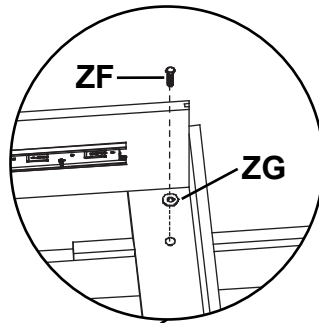

Fig. 4a

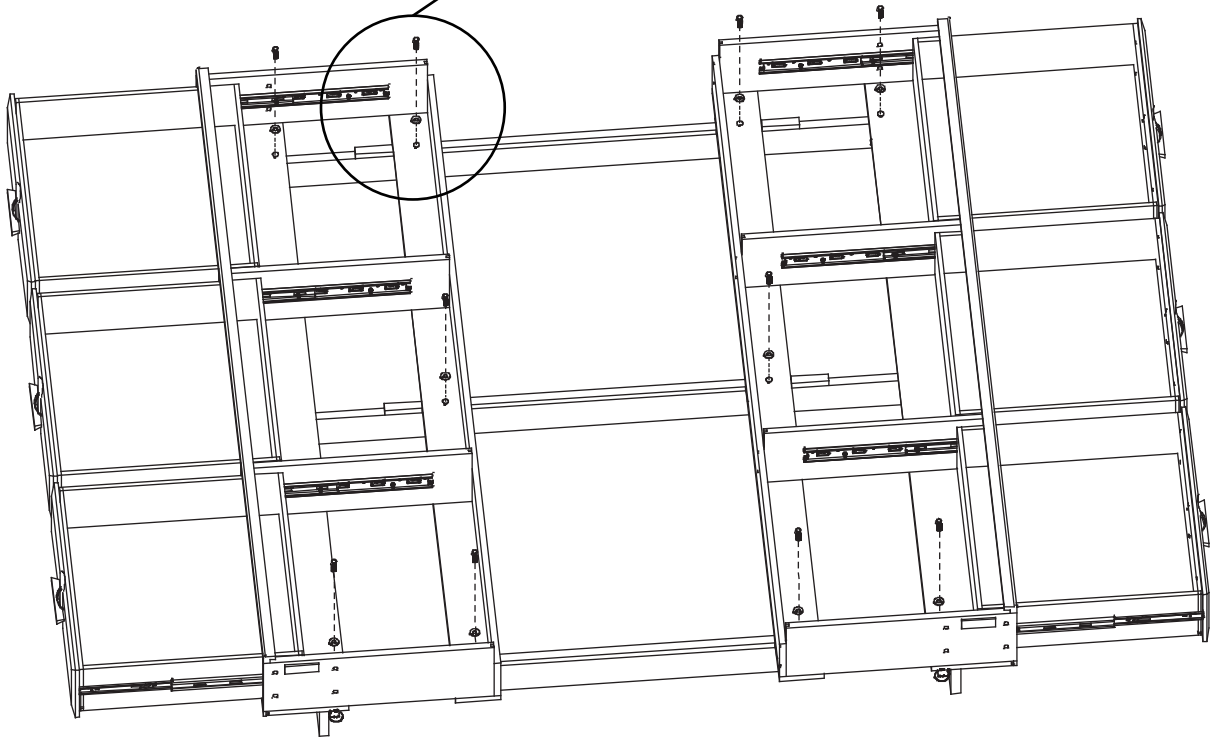

Fig. 4

(Notched Deckboards removed for illustration purposes)

3838DUETa Addison Queen Bookcase Storage Bed

Assembly Instructions

This assembly requires two people.

5. NOTE: When attaching the Footboard (B) to the Pedestal/Base assembly attach it at the end of the Base with the leveler behind the crosspiece.

There are two options to attach the Footboard (B) to the Pedestal Assembly. Option a) Release the two drawers (E) at the end of the assembly as shown in Fig. 5a. Open the Drawers (E) until the back edge of the drawer is even with the front of the Pedestal. Reach under the attached deckboard from the backside of the pedestal and insert Bolts (ZF) and Washers (ZG) into the Footboard (B). Push the drawers closed. Option b) remove the two end drawers (E) completely. Insert the bolts and washers into the Footboard and reinstall the drawers. See Fig. 5b, 5c.

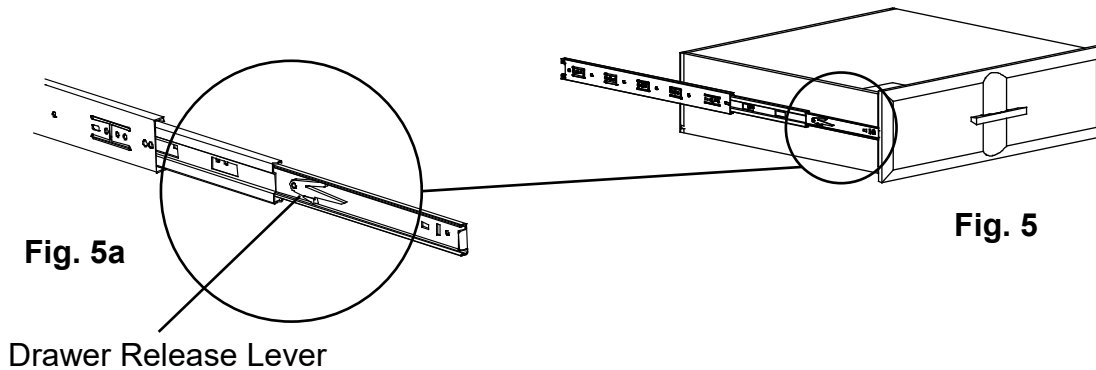

Option 5b shown in illustration

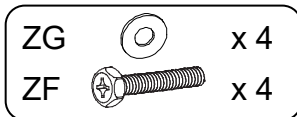
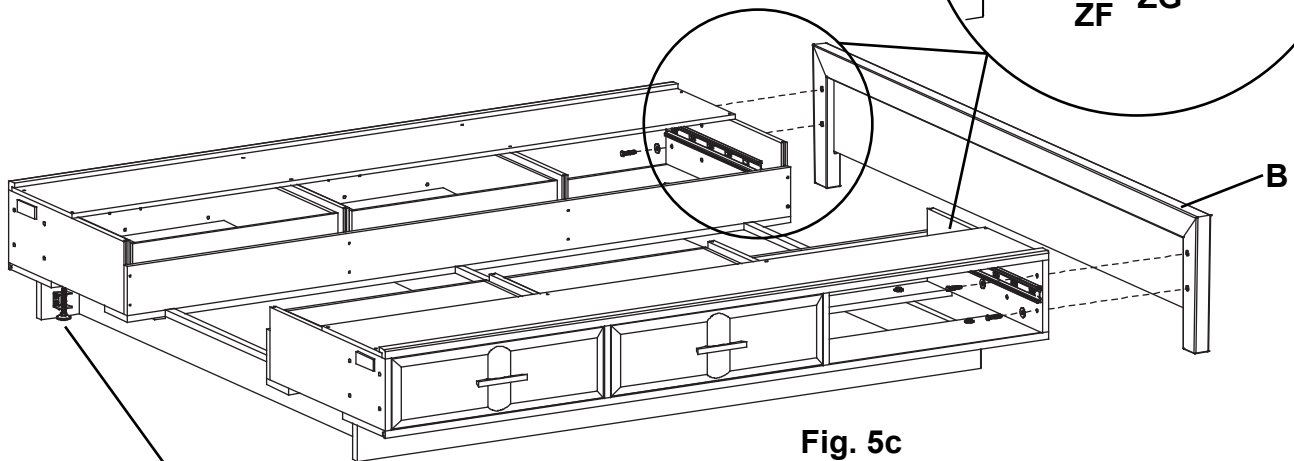
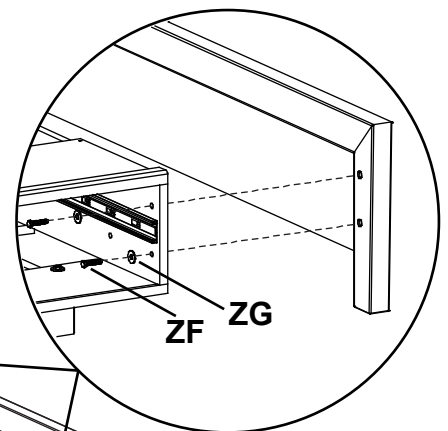

Fig. 5b



Headboard end of Base has leveler outside the crosspiece



3838DUETa Addison Queen Bookcase Storage Bed

Assembly Instructions

This assembly requires two people.

6. Attach the Headboard (Aa) with Hex Bolts (ZF) and Washers (ZG) using assembly option a) or b) from Step 5. See Figures 6 and 6a.



ZG		x 4
ZF		x 4

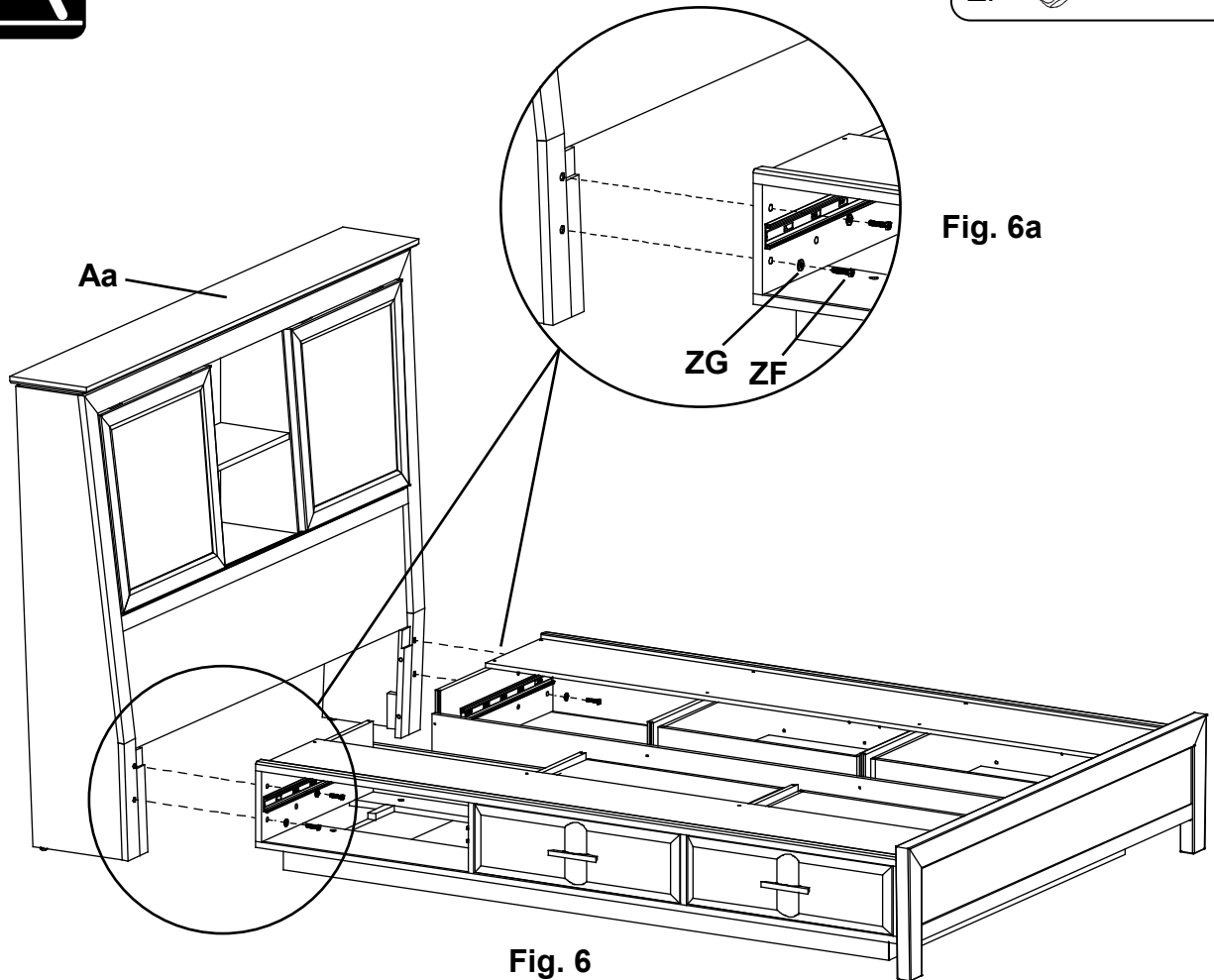

Option 5b shown in illustration

3838DUETa Addison Queen Bookcase Storage Bed

Assembly Instructions

This assembly requires two people.

- Once the Headboard and Footboard are attached, open all drawers and tighten Hex Bolts (ZF) and Washers (ZG) on the inside of the bed assembly.
- Adjust levelers (ZC) only if floor is uneven or if bed has movement . See Figures 8 and 8a. Using a slotted screwdriver, rotate the Large Adjustable Glide (ZR) clockwise until it bears weight. Repeat for the opposite side. See Figure 8b.
This is important if the bookcase headboard sits upon a carpet tack strip.

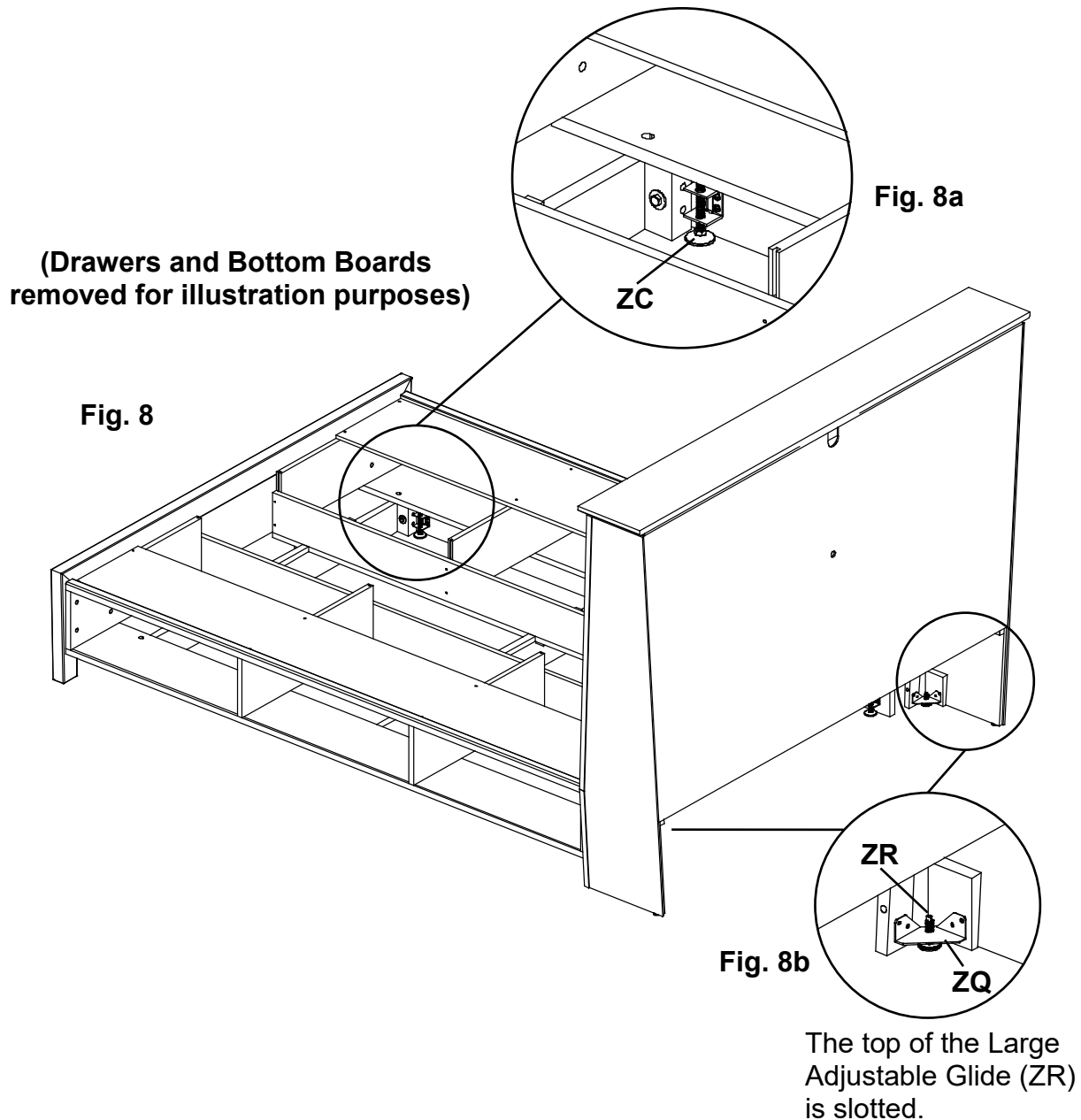

3838DUETa Addison Queen Bookcase Storage Bed

Assembly Instructions

This assembly requires two people.

9. Insert Trestle Rail Supports (U). See Figures 9 and 9a.

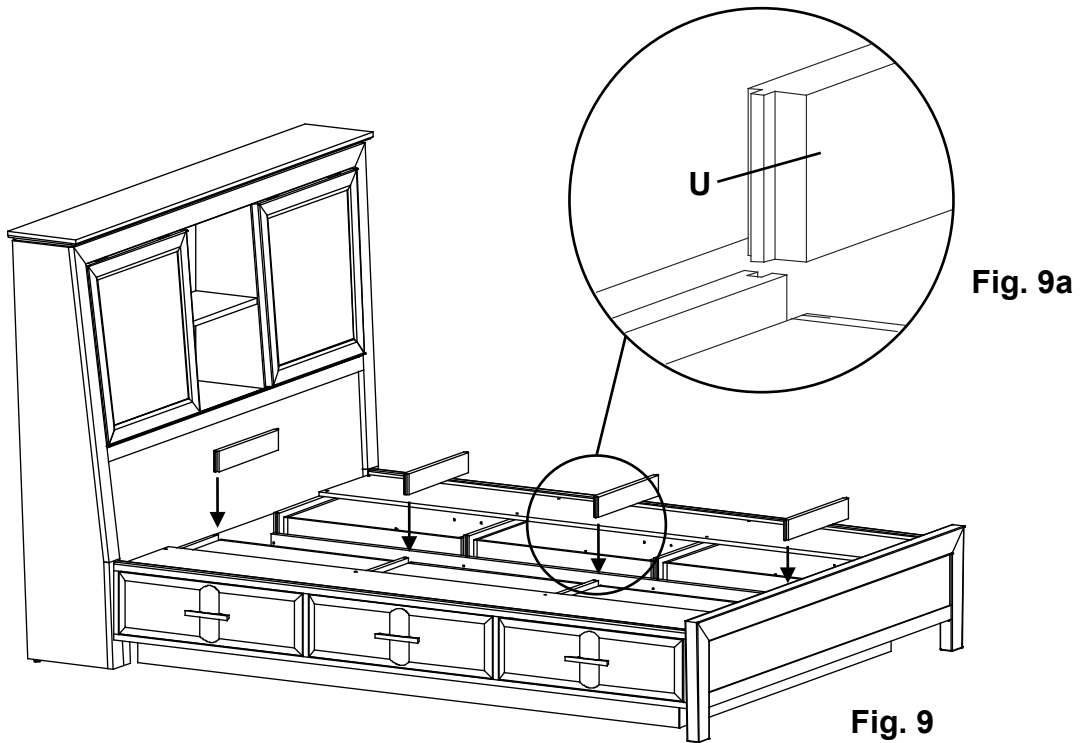

10. Place the Left/Right Center Deckboards (G) as shown in Figure 10 and secure with twelve #8x1-1/4" Black Screws (L). There should be a small gap between each deckboard. See Figure 10.

