

McKenzie Alder Cabinet Finished Program

Assembly Instructions

Model #

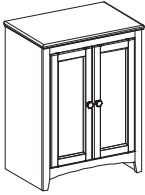

1613b

**McKenzie Alder
Cabinet 24"W**

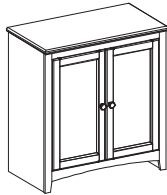

1619b

**McKenzie Alder
Cabinet 30"W**

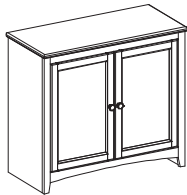

1625b

**McKenzie Alder
Cabinet 36"W**

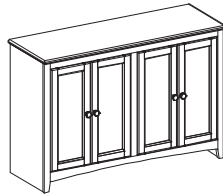

1631b

**McKenzie Alder
Cabinet 48"W**

Thank you for allowing us to help you furnish your home. We are certain you will be delighted with your new furniture for many years to come.

IMPORTANT NOTES:

- For normal household use only. *Not* recommended for commercial use.
- Do not climb, sit or stand on this piece of furniture.
- Do not overload the shelves.
- Unload items before you move this unit.
- Before you begin your project, completely read the Assembly Instructions.
- This assembly requires two people.

WARNING

Children have died from furniture tipover. To reduce the risk of furniture tipover:

- ALWAYS install tipover restraint provided.
- NEVER put a TV on this product.
- NEVER allow children to stand, climb or hang on doors, or shelves.
- Place heaviest items on the bottom shelves.

Use of tipover restraints may only reduce, but not eliminate, the risk of tipover.

Attention: Attached to the bottom of or included with this unit is a tipping restraint kit. When you receive your furniture, be sure to find and install the tipping restraint as instructed in the kit. If you cannot locate the restraint, please contact us immediately for replacement.

Drilling, sawing, sanding or machining wood products can expose you to wood dust, a substance known to the state of California to cause cancer. Avoid inhaling wood dust or use a dust mask or other safeguards for personal protection.

For more information go to: www.p65warnings.ca.gov/wood

This product can expose you to chemicals, including formaldehyde, which are known to the State of California to cause cancer.

For more information go to: www.p65warnings.ca.gov/furniture

DESIGN SUBJECT TO CHANGE WITHOUT NOTICE.

CUSTOMER SERVICE

If you ever have questions about your furniture, please do not hesitate to contact us. In the unlikely event you need a replacement part; we can make those parts available through an authorized Whittier Wood Furniture dealer. If you cannot order replacement parts through your dealer, please contact our customer service department.

Hours: Our friendly customer service staff can be reached:

Monday-Friday 8:00 a.m. to 5:00 p.m. (Pacific Time).

You may leave a message 24 hours a day, seven days a week.

Customer Service: 800-653-3336 • **Outside the U.S.:** 541-687-0213

Fax: 541-687-2060 • **Email:** info@whittierwood.com

**Whittier
Wood**
FURNITURE

P.O. Box 2827
Eugene, OR 97402 USA

Production Code:

09/20

1613b; 1619b; 1625b & 1631b McKenzie Alder Cabinet

Parts List

Before you begin to assemble this unit, identify each part and make sure the quantities received match what is on this list.

If you need to replace a part, please refer to the following list for the finish, part name and letter code.

Bookcase Finish

Please note the finish of the bookcase for replacement part orders.
Bookcase finish options are subject to change.

Stain









GAC	Glazed Antique Cherry	CAF	Caffè	FST	Fieldstone	HAZ	Hazelnut	NA	Natural Alder
------------	-----------------------	------------	-------	------------	------------	------------	----------	-----------	---------------

Paint



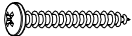
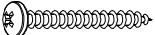
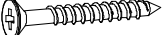



SN	Snowbound SW 7004	AW	Aged White SW 9180	SL	Silverplate SW 7649	TB	Tricorn Black SW 6258
-----------	-------------------	-----------	--------------------	-----------	---------------------	-----------	-----------------------

Two-Tone

SNN	Snowbound SW 7004 Natural Alder	AWN	Aged White SW 9180 Natural Alder	SLN	Silverplate SW 7649 Natural Alder	TBN	Tricorn Black SW 6258 Natural Alder
------------	------------------------------------	------------	-------------------------------------	------------	--------------------------------------	------------	--

Part	Description	Quantity			
		1613b	1619b	1625b	1631b
A	Top Assembly (attached) 	1	1	1	1
B	Case 	1	1	1	1
C	Door (attached) 	2	2	2	4
D	Adjustable Shelf (installed) 	1	1	1	2
E	#6 x 1/2" Undercut Screw (inserted) 	4	4	4	8
F	#8 x 1" Pan Head Screw (inserted) 	8	8	10	10
G	#8 x 1-1/4" Pan Head Screw (inserted) 	8	8	8	8
H	#8 x 1-1/4" Black Screw (inserted) 	0	0	0	3
I	#8 x 1-1/2" Machine Screw Tuscan (installed) 	2	2	2	4
J	#639C Hinge (attached) 	4	4	4	4
K	Hinge Plate (attached) 	4	4	4	8
L	#639B Hinge (attached) 	0	0	0	4

1613b; 1619b; 1625b & 1631b McKenzie Alder Cabinet
Parts List

Part	Description		Quantity			
			1613b	1619b	1625b	1631b
N	Hex Bumper (attached)		2	2	2	4
O	Knob (attached)		2	2	2	4
P	Nylon Insert (inserted)		4	4	4	4
R	Shelf Bracket (installed)		4	4	4	8
TB	Bookcase Tipping Restraint (attached)		1	1	1	1
U	Slotted Leveler (installed)		4	4	4	4
Ua	Leveler Adjustment Key (attached to Owner's Manual)		1	1	1	1

1631 shown in the illustrations.

1613b; 1619b; 1625b & 1631b McKenzie Alder Cabinet

Parts List

Tools Required: Phillips Screwdriver, Pencil, Rubber mallet or Padded hammer.

Tools Provided: Leveler Adjustment Key in the Zip bag taped to the Owner's Manual and Safety Guide.

1. Place the unit at its final destination. Use the Leveler Adjustment Key (Ua), found in the Zip bag taped to the Owner's Manual and Safety Guide to rotate the Slotted Levelers (U) on the bottoms of the legs until the unit is level. See figures 1 and 1a.

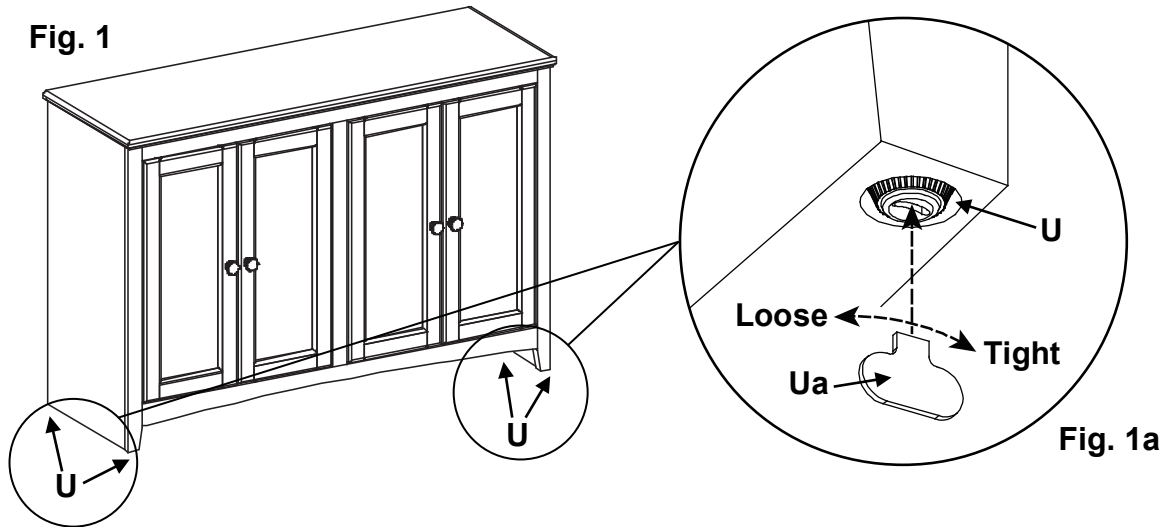

2. **To move the adjustable shelves:**

Determine where you want to place the Adjustable Shelves (D). Remove the #6 x 1/2" Undercut Screws (E) from the underside of the shelf and take out the Shelf and Shelf Brackets (R). Insert the Shelf Brackets (flat side down) into the four different holes and insert the shelf. You may secure them by inserting #6 x 1/2" Undercut Screws (E). See Figures 2 and 2a.

Door removed for illustration purposes.

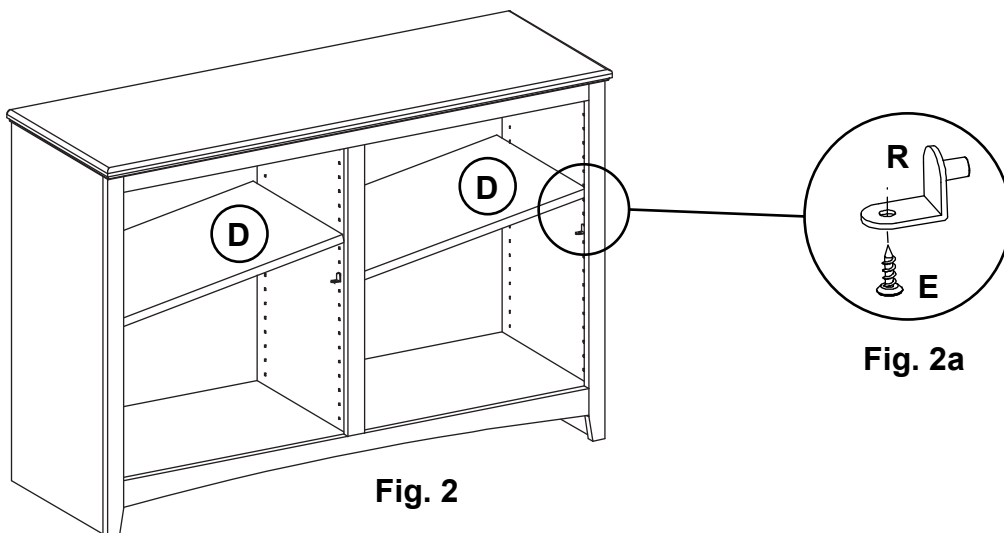

1613b; 1619b; 1625b & 1631b McKenzie Alder Cabinet

Parts List

3. To adjust the doors, follow the instructions below.

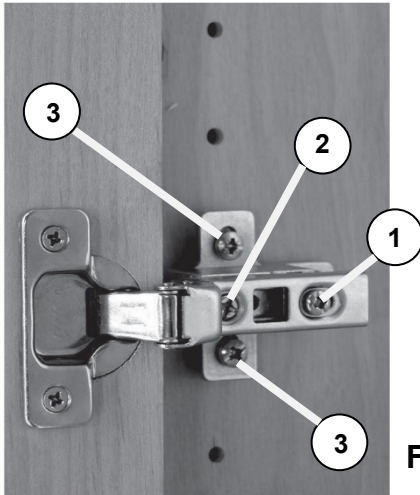

Fig. 3

Side adjustment

To move the door towards the side panel, rotate screw '2' counter-clockwise. To move the door away from the side panel, rotate screw '2' clockwise.

Depth Adjustment

Loosen screw '1' and adjust the door. Re-tighten screw.

Height Adjustment





Loosen screws '3' and adjust the door. Re-tighten screw.

Continued on Page 6

1613b; 1619b; 1625b & 1631b McKenzie Alder Cabinet
Parts List

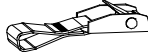
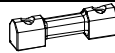
Bookcase Tipping Restraint Instructions

Before you begin this assembly, identify each part and make sure the quantities received match what is on this list. If you need to replace a part, contact Whittier Wood Furniture customer service and refer to the following list for its name and letter code.

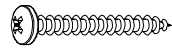
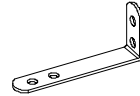
Part	Description	Quantity
A	Cam Buckle and Short Strap (installed) 	1
B	Plastic Bracket (installed) 	1
C	1" x 1000mm Long Strap (installed) 	1
D	#8 x 3" Pan Head Screw 	2
F	Washer (installed) 	1
G	#8 x 5/8" Pan Head Screw 	2 (1 inserted)
H	#8 x 1-1/4" Pan Head Screw 	1
I	"L" Angle Bracket 	1

If you have a stone or tile floor or do not wish to drive screws into the corner of the baseboard and floor see the instruction included inside the tipping restraint kit for an alternate installation.

Continued on Page 7

1613b; 1619b; 1625b & 1631b McKenzie Alder Cabinet

Parts List

- Decide where you want to place the bookcase in your room. Mark the baseboard with a pencil mark directly behind the location where the tipping restraint is attached to your item. Move the item away from the wall far enough to allow you to access the spot where the baseboard meets the floor. Position the straps and Plastic Bracket (B) as shown in Figures 4 and 4a with the angled corners of the Plastic Bracket (B) firmly placed against the seam of the baseboard and floor. Attach by driving #8 x 3" Pan Head Screws (D) through the holes in the Plastic Bracket (B) into the seam below the baseboard where it meets the floor. See Figures 4 and 4a.

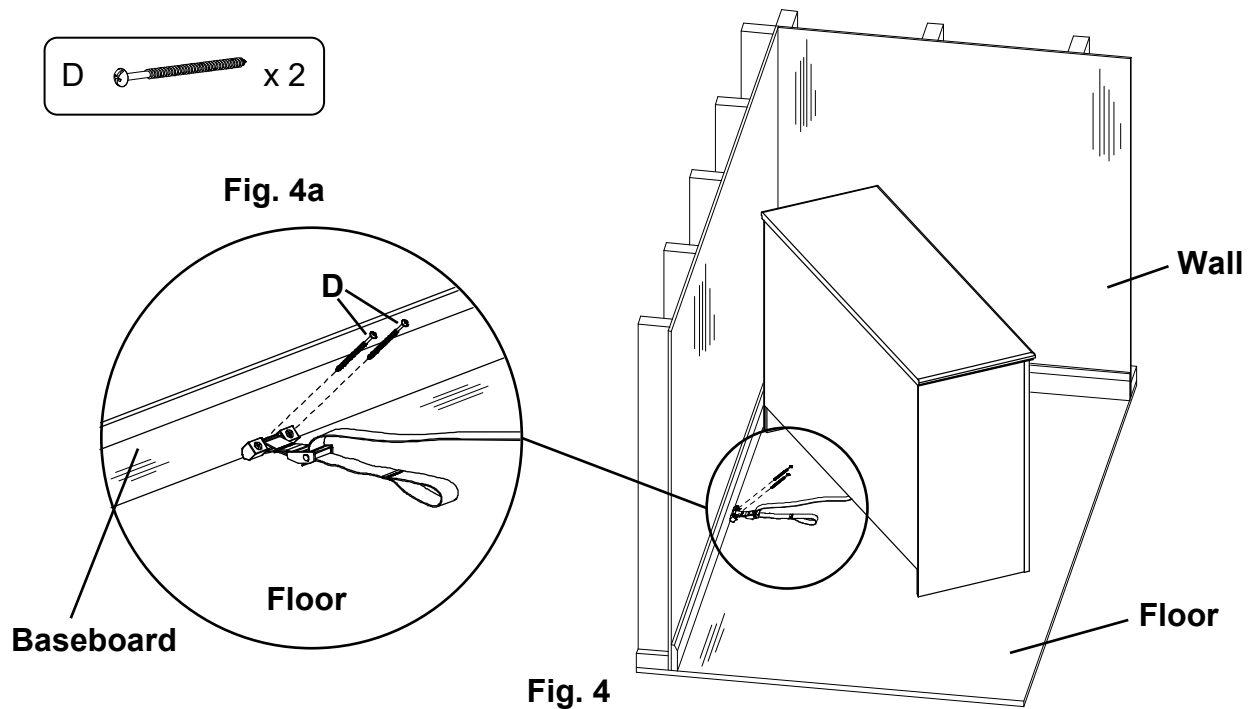

- Move the item back into position against the wall and reach underneath the bookcase to grasp the loop in the free end of the strap. Pull the free end of the strap until portion between the Cam Buckle (A) and the bottom of the item is tight. See Figures 5 and 5a. If you need to move the bookcase reach beneath and locate the buckle which connects the two sections of the strap and depress the release lever, then pull on the section of strap that is between the buckle and the bottom of the furniture until there is enough slack to allow you to pull the item away from the wall.

1613b; 1619b; 1625b & 1631b McKenzie Alder Cabinet
Parts List

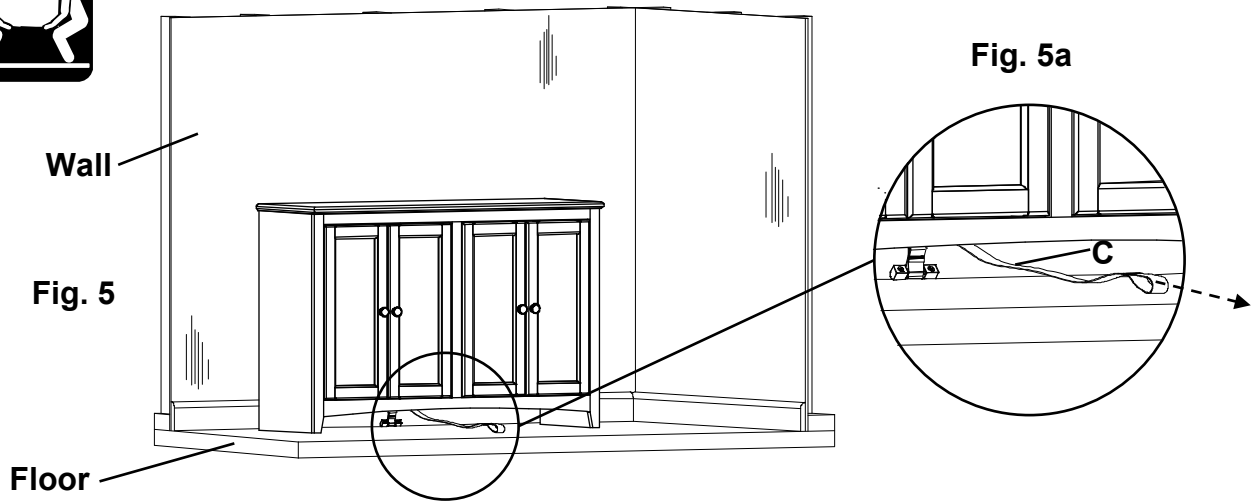

6.