

Model #

2711DUETa

Addi Chair

Duet finish

Assembly Instructions

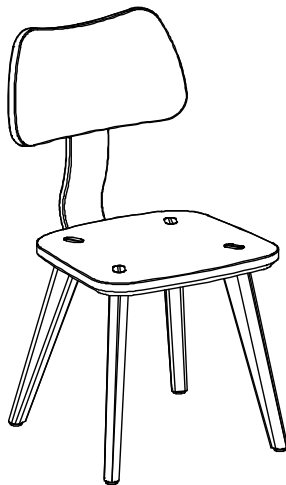

Thank you for allowing us to help you furnish your home. We are certain you will be delighted with your new furniture for many years to come.

IMPORTANT NOTES:

- Wood can be susceptible to changing color over time when exposed to strong sunlight. Use window shades, drapes or blinds to protect your furniture. To help the surface age evenly and avoid dark and light spots, periodically move items to expose the entire surface to an even amount of light so it may develop a uniform patina.
- For normal household use only. *Not* recommended for commercial use.
- Do not climb or stand on this piece of furniture.
- Unload items before you move this unit.

WARNING

Drilling, sawing, sanding or machining wood products can expose you to wood dust, a substance known to the state of California to cause cancer. Avoid inhaling wood dust or use a dust mask or other safeguards for personal protection.

For more information go to: www.p65warnings.ca.gov/wood

This product can expose you to chemicals, including formaldehyde, which are known to the State of California to cause cancer. For more information go to: www.p65warnings.ca.gov/furniture

DESIGN SUBJECT TO CHANGE WITHOUT NOTICE.

CUSTOMER SERVICE

If you ever have questions about your furniture, please do not hesitate to contact us. In the unlikely event you need a replacement part; we can make those parts available through an authorized Whittier Wood Furniture dealer. If you cannot order replacement parts through your dealer, please contact our customer service department.

Hours: Our friendly customer service staff can be reached:

Monday-Friday 8:00 a.m. to 5:00 p.m. (Pacific Time).

You may leave a message 24 hours a day, seven days a week.

Customer Service: 800-653-3336 • **Outside the U.S.:** 541-687-0213

Fax: 541-687-2060 • **Email:** info@whittierwood.com

**Whittier
Wood**
FURNITURE

P.O. Box 2827
Eugene, OR 97402 USA

Production Code:







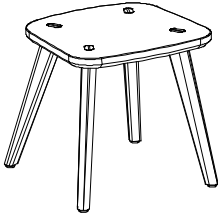
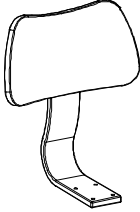

VN

02/19

2711DUETa Addi Chair

Parts List

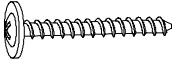
Please identify the parts and check that quantities received match those on this list.
If you need to replace a part, refer to the following letter and part name.

Part	Description	Quantity
Aa	Seat Assembly 	1
B	Back Assembly 	1
C	1" Flat Washer 	4
D	5/16" x 35mm Hex Bolt 	4
E	5/16" x 10mm T-Nut (inserted) 	4
F	Wool Felt Pad/Glide (attached) 	4
G	#8 x 1-1/4" Black Screw (inserted) 	5
H	#8 x 1-3/8" Lo-Profile Screw (inserted) 	6
I	Anti-Flex Support (attached) 	1

2711DUETa Addi Chair

Assembly Instructions

Tools Required: Phillips screwdriver, 1/2" open end or box end wrench

1. Turn the Seat Assembly (Aa) upside-down on a clean, protected surface. Attach the Back Assembly (B) to the Seat Assembly (Aa) with four 5/16" x 35mm Hex Bolts (D) and four 1" Flat Washers (C). See Figure 1.

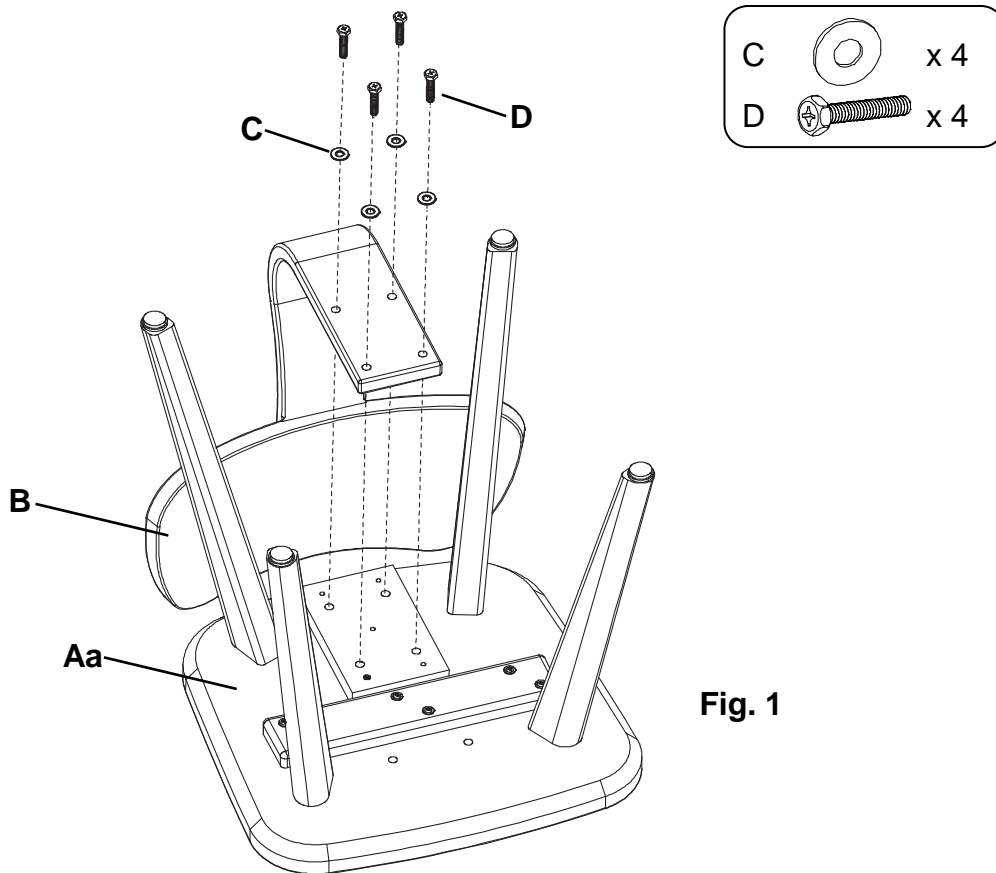

Fig. 1

2. Turn the chair upright and place at its final destination. See Figure 2.

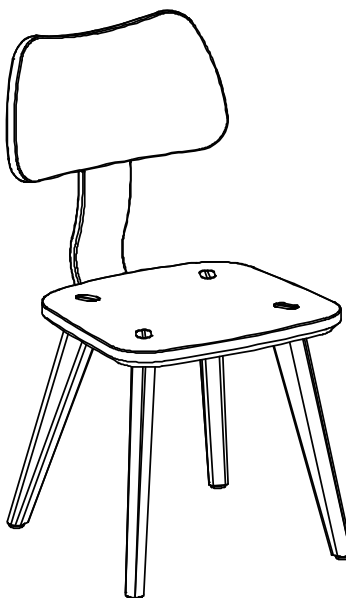

Fig. 2