

Model #

# 1501GSPb 1501CAFb

## Pacific Beveled Mirror

**GSP = Glazed Spice finish**

**CAF = Caffè finish**

*Assembly Instructions*

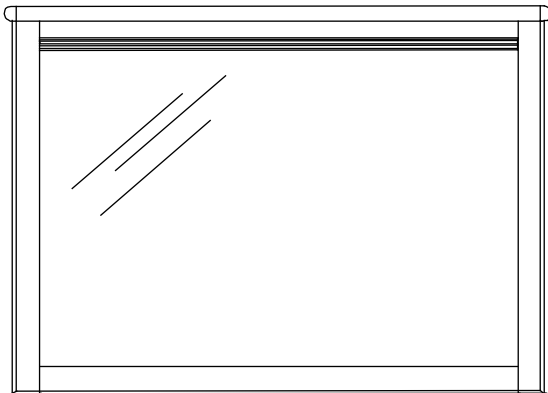

*Thank you for allowing us to help you furnish your home. We are certain you will be delighted with your new furniture for many years to come.*

### IMPORTANT NOTES:

- For normal household use only. *Not* recommended for commercial use.



- Handle the mirror with care. Glass is fragile.
- Tighten or repair as needed.

### **WARNING**

Drilling, sawing, sanding or machining wood products can expose you to wood dust, a substance known to the state of California to cause cancer. Avoid inhaling wood dust or use a dust mask or other safeguards for personal protection.

For more information go to: [www.p65warnings.ca.gov/wood](http://www.p65warnings.ca.gov/wood)

This product can expose you to chemicals, including formaldehyde, which are known to the State of California to cause cancer.

For more information go to: [www.p65warnings.ca.gov/furniture](http://www.p65warnings.ca.gov/furniture)

**DESIGN SUBJECT TO CHANGE WITHOUT NOTICE.**

### CUSTOMER SERVICE

If you ever have questions about your furniture, please do not hesitate to contact us. In the unlikely event you need a replacement part; we can make those parts available through an authorized Whittier Wood Furniture dealer. If you cannot order replacement parts through your dealer, please contact our customer service department.

**Hours:** Our friendly customer service staff can be reached:

**Monday-Friday 8:00 a.m. to 5:00 p.m. (Pacific Time).**

You may leave a message 24 hours a day, seven days a week.

**Customer Service:** 800-653-3336 • **Outside the U.S.:** 541-687-0213

**Fax:** 541-687-2060 • **Email:** [info@whittierwood.com](mailto:info@whittierwood.com)



P.O. Box 2827  
Eugene, OR 97402 USA

Production Code:







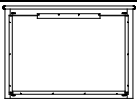
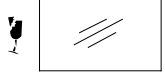
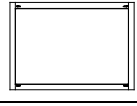
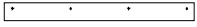

VN

03/17

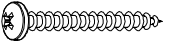
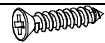
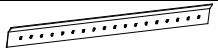
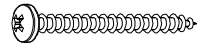
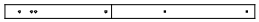
# 1501GSPb 1501CAFb Pacific Beveled Mirror

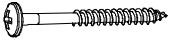
## Parts List

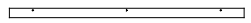
Please identify the parts and check that quantities received match those on this list.  
If you need to replace a part, refer to the following letter and part name.

Part	Description		Quantity
Ab	Mirror Assembly		1
B	Mirror		1
Cb	Mirror Frame (attached)		1
D	Mirror Frame Bracket (attached)		1
F	Top (attached)		1
G	#8 x 1-1/4" Pan Head Screw (inserted)		8
H	#6 x 3/4" Flat Head Screw (inserted)		4
I	Mirror Wall Bracket		1
J	#8 x 1-3/4" Pan Head Screw		2
K	Mirror Support		2
L	M4 x 41 mm Machine Screw		4
M	#7 x 1-1/2" Black Pan Head Screw		4
N	Velvet Pad 50 x 50mm		3
O	Short Mirror Retainer (attached)		2
P	Long Mirror Retainer (attached)		1
Q	#6 x 1/2" Philtruss Screw (inserted)		10

# 1501GACb 1501CAFb Beveled Mirror

## Assembly Instructions

**Tools Required:** Phillips Screwdriver, Tape Measure, Pencil

**You have the option of attaching your Mirror to the wall or to selected Pacific Dressers. To attach the Mirror to a wall, follow steps 1-3. To attach the Mirror to the Dresser, follow steps 4-7.**

1. Determine where you want the bottom of your mirror to end and draw a faint pencil line on the wall. Use a tape measure and measure up 25-3/8" from that line. Draw another faint line. The top line is where you attach the Mirror Wall Bracket (I). If you like, you can erase the faint bottom pencil mark. See Figure 1.

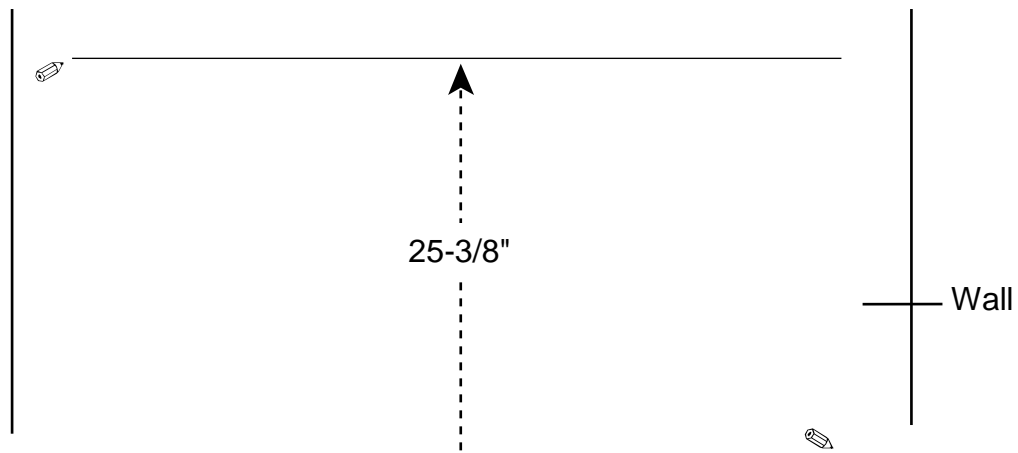

**Fig. 1**

2. Locate two studs in the wall behind the space where you want to hang your Beveled Mirror. Affix the Mirror Wall Bracket (I) into the studs with two #8x1-3/4" Pan Head Screws (J). If you cannot locate two studs, purchase the proper wall attachment hardware for your type of wall and secure the bracket. See Figure 2.

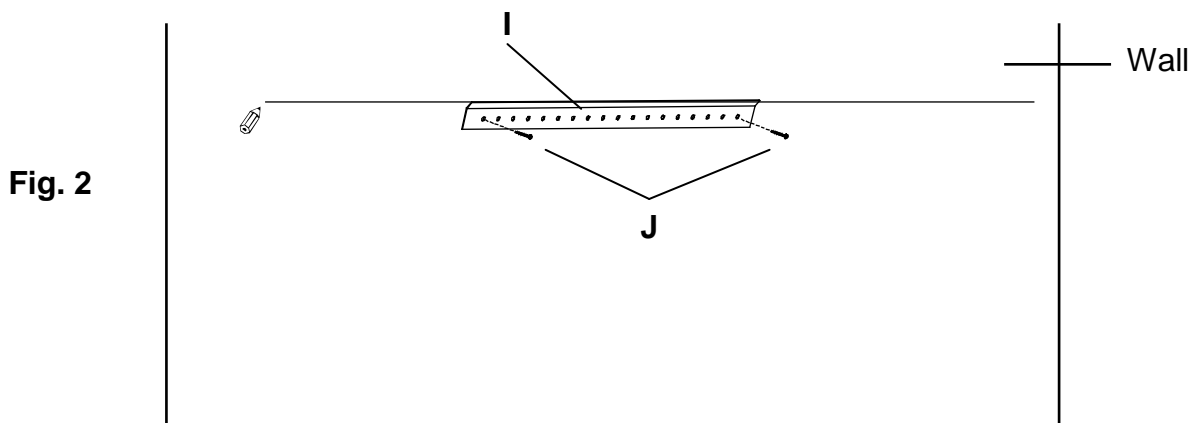
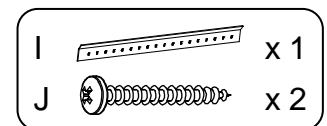

**Fig. 2**

# 1501GACb 1501CAFb Beveled Mirror

## Assembly Instructions

---

3. NOTE: The Mirror Wall Bracket (I) angles out at the top. When you hang your Beveled Mirror, the Mirror Frame Bracket (D) fits over the angled part of the Mirror Wall Bracket (I). See Figure 3.

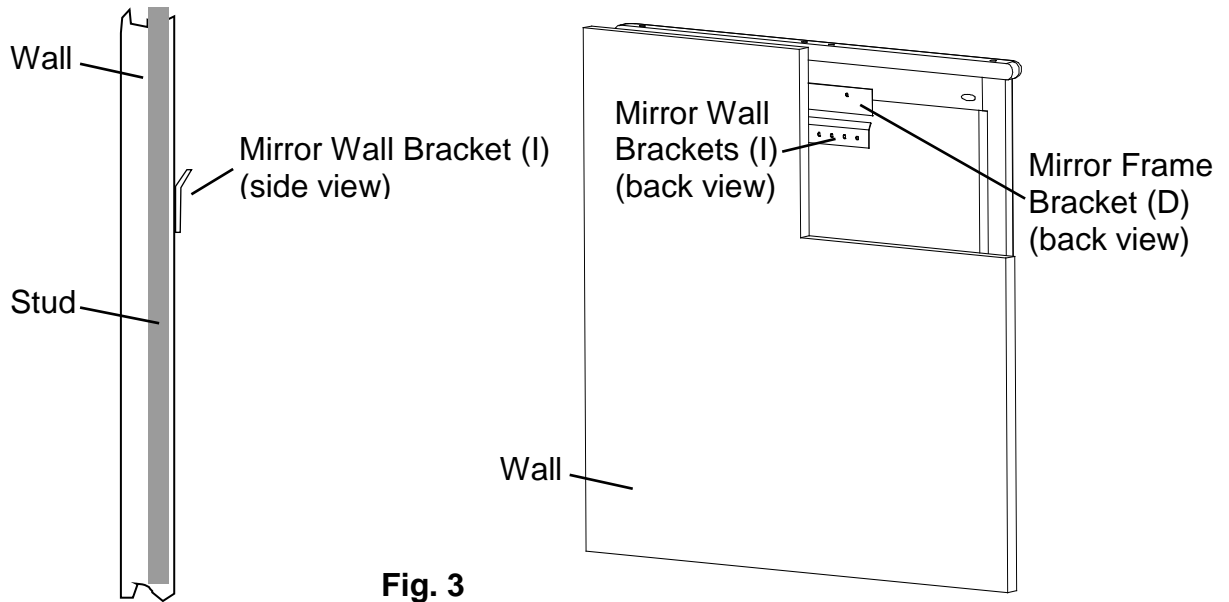
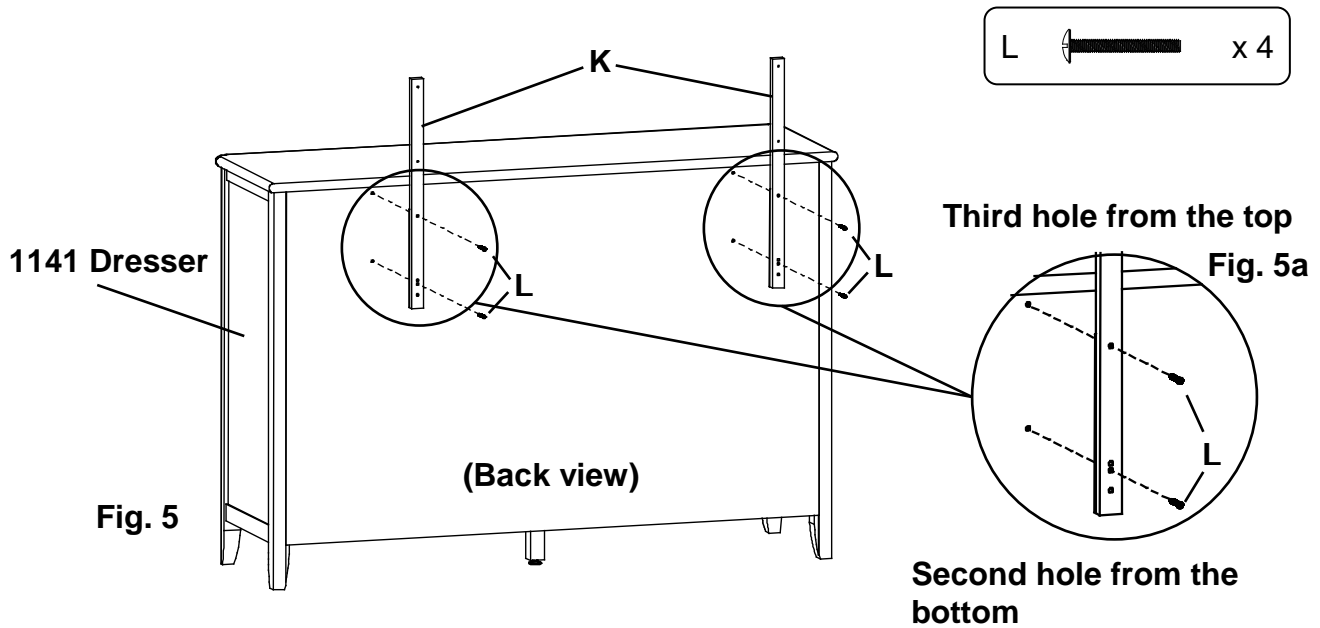

**Fig. 3**

# 1501GACb 1501CAFb Beveled Mirror

## Assembly Instructions

- To attach the Mirror to a Pacific Dresser, remove the Mirror Frame Bracket (D) that is attached to the Mirror Frame (Cb). Keep this bracket along with the Mirror Wall Bracket (I) and the two #8x1-3/4" Pan Head Screws (J) in the chance that in the future, you want to mount the Mirror to the wall.
- Using the predrilled holes on the back of the Dresser as guides, attach the two Mirror Supports (K) with four M4 x 41 Machine Screws (L). Insert the upper screws into the third hole from the top and insert the lower screws into the second hole from the bottom of the Mirror. See Figure 5 and 5a. Supports. See Figures 5 and 5a.



# 1501GACb 1501CAFb Beveled Mirror

## Assembly Instructions

---

6. Peel off the backings on the Velvet Pads (N) and apply them to the bottom of the Mirror Assembly (Ab). See Figure 6.

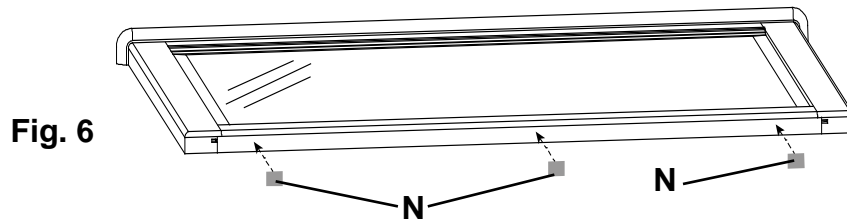

7. Place the Mirror on top of the Dresser and attach it to the Mirror Supports (K) with four #7 x 1-1/2" Black Pan Head Screws (M). See Figure 7.

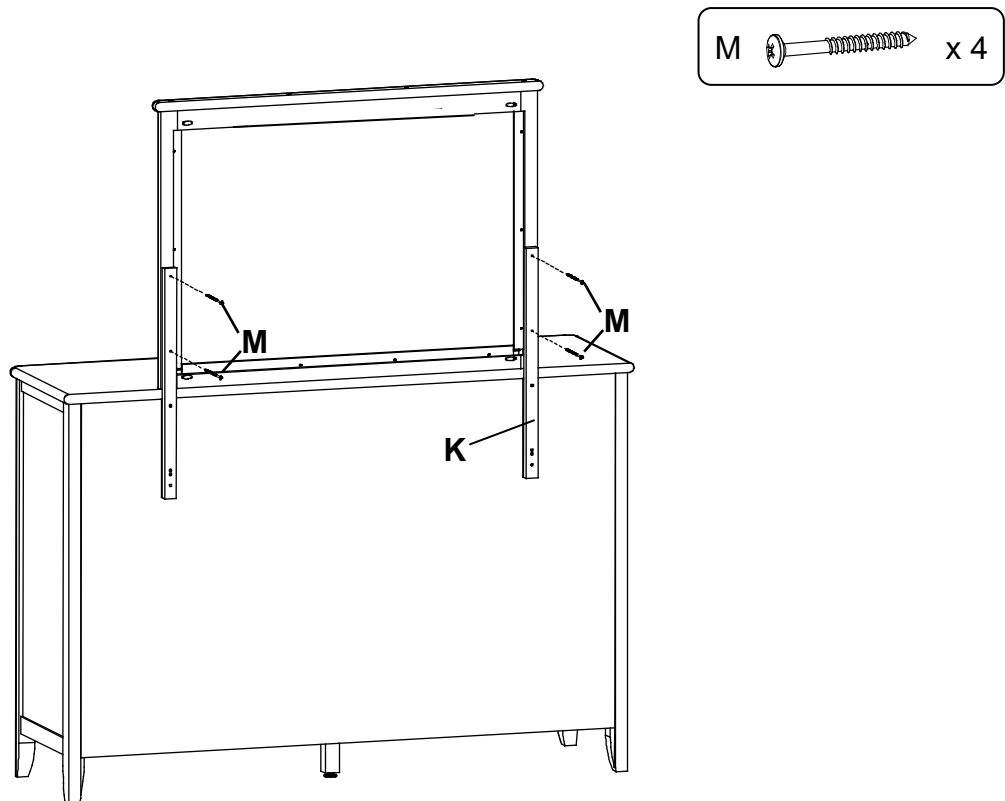

**Fig. 7**