

Model #

1221AFLSOc; 1221AFDAOc

11-Drawer Prairie City Dresser

AFLSO = Summer Oak finish

AFDAO = Autumn Oak finish

Assembly Instructions

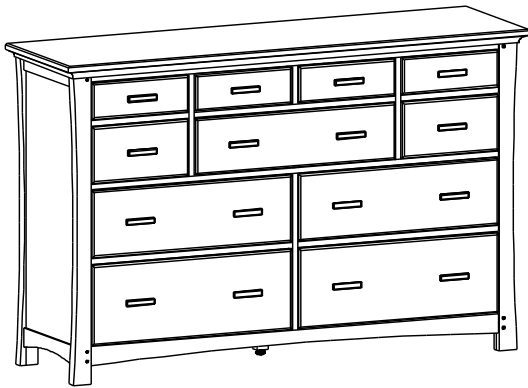

Congratulations!

This fine piece of furniture will make a gorgeous addition to your home. For the best results, read the Assembly Instructions before you begin your project.

IMPORTANT NOTES:

- For normal household use only. *Not* recommended for commercial use.
- Do not climb, sit or stand on this piece of furniture.
- Do not overload the drawers.
- Unload items before you move this unit.
- Before you load or move this unit, tighten all screws and supports.
- Before you begin your project, completely read the Assembly Instructions.
- Store this item: 1- in its box; 2- in a dry place; 3- in temperatures that range from 40°F to 90°F (not on a cold and possibly damp cement floor).
- Periodically inspect your furniture for any loose glue joints, screws or any other problem that might affect the stability of your furniture. Tighten or repair as needed.
- This assembly requires two people.

! WARNING

Serious or fatal crushing injuries can occur from furniture tip-over. Use of tip-over restraints may only reduce but not eliminate the risk of tip-over.

To help prevent tip-over:

- Place heaviest items in the bottom drawers.
- Unless specifically designed to accommodate, do not set TVs or other heavy objects on top of this product.
- Never allow children to climb or hang on drawers, doors or shelves.
- Never open more than one drawer at a time.

Warning: At least one tipping restraint kit was included with your piece of Whittier Wood Furniture. When you receive your furniture, be sure to find and properly install the tipping restraint(s). If you cannot locate the restraint(s), please contact us immediately for replacement.

Notice to California Customers

California Prop 65 requires consumer goods to be labeled if any one of 850+ different chemicals or substances, including wood dust, is present even in trace amounts. Drilling, sawing, sanding or machining wood products generates wood dust, a substance known to the State of California to cause cancer. **Warning:** This product contains a chemical or substance known to the State of California to cause cancer, birth defects or other reproductive harm. *California Health and Safety Code Section 25249.6*

DESIGN SUBJECT TO CHANGE WITHOUT NOTICE.

CALL US FIRST! *Do not return this item to the store*

Service Policy: We will replace any part that is defective, missing or damaged during assembly. For a replacement part, phone, fax, mail or email your request to the Whittier Wood Products customer service department.

Hours: Our friendly customer service staff can be reached Monday-Friday 7:00 a.m. to 5:00 p.m. (Pacific Time). You may leave a message 24 hours a day, seven days a week.

To Order: Provide the finish and furniture model number (upper portion of this page), the part letter, production code, quantity needed, reason for replacement and your full name, address and telephone number.

Parts ship from our Eugene, Oregon factory within one or two business days from the time we receive your request. Please allow five to ten business days for delivery.

800-653-3336 • Outside the U.S. or Canada: 541-687-0213 • Fax: 541-687-2060
www.whittierwood.com • P.O. Box 2827 • Eugene, Oregon 97402, U.S.A.



P.O. Box 2827
Eugene, OR 97402 USA

Production Code:











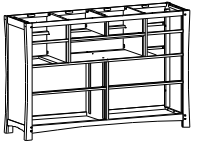
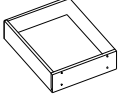
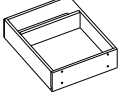
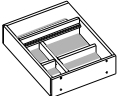

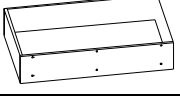

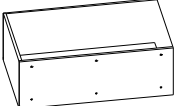
VN

03/14

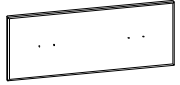

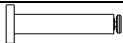

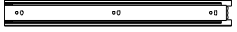











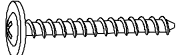
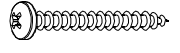





1221AFLSOc; 1221AFDAOc 11-Drawer Prairie City Dresser

Parts List

Please identify the parts and check that quantities received match those on this list.
If you need to replace a part, refer to the following letter(s) and part name.

Part	Description		Quantity
A	Top Assembly (attached)		1
B	Case		1
C	Left/Right Top Drawer Box (inserted)		2
D	Left Secret Storage Drawer Box (inserted)		1
E	Right Secret Storage Drawer Box (inserted)		1
F	Left/Right Upper Middle Drawer Box (inserted)		2
G	Center Upper Middle Drawer Box (inserted)		1
H	Lower Middle Drawer Box (inserted)		2
I	Large Bottom Drawer Box (inserted)		2
J	Top Drawer Face (installed)		4
K	Left/Right Upper Middle Drawer Face (installed)		2
L	Center Upper Middle Drawer Face (installed)		1
M	Lower Middle Drawer Face (installed)		2
N	Large Bottom Drawer Face (installed)		2
O	Tray (inserted)		1
P	Assembled Foot (attached)		1
Q	16" Drawer Slides (pre-installed set)		2
R	14" Drawer Slides (pre-installed sets)		9
S	#6 x 5/8" Undercut Screw (inserted)		4

1221AFLSOc; 1221AFDAOc 11-Drawer Prairie City Dresser
Parts List

Part	Description		Quantity
T	#6 x 3/4" Philtruss Screw (inserted)		66
U	#6 x 1/2" Philtruss Screw (inserted)		66
V	Adjustable Glide with Hex Nut (installed)		1
W	#8 x 1-1/8" Lo-Profile Screw (inserted)		4
Xa	#8 x 7/8" Black Lo-Profile Screw (inserted)		54
Y	#8 x 1-3/8" Lo-Profile Screw (inserted)		13
ZA	#8 x 1-1/4" Pan Head Screw (inserted)		24
ZC	#8 x 1-1/4" Black Screw (inserted)		5
ZD	#8 x 2" Black Screw (inserted)		2
ZF	Hinged Drawer Stop (attached)		2
ZG	5/16" x 3/4" Insert Nut (inserted)		1
ZH	1/4" x 20mm Insert Nut (inserted)		4
ZI	4 x 10mm Insert Nut (inserted)		4
ZJ	Pull (attached)		16
ZK	Hex Bumper (attached)		4
ZL	Velvet back of sleeper 50 x 20mm (attached)		2
ZM	Velvet Tray bottom 248 x 186mm (attached)		1
ZN	Velvet Secret storage drawer bottom 400 x 302mm (attached)		1
ZO	Short Velvet 200 x 12mm (attached)		2
ZP	Long Velvet 280 x 12mm (attached)		2
ZQ	Small Adjustable Glide (installed)		4
ZR	#8 x 1-1/2" Machine Screw Tuscan (installed)		32
TS	Furniture Tipping Restraint (attached)		1 set

1221AFLSOc; 1221AFDAOc 11-Drawer Prairie City Dresser

Assembly Instructions

Tool Required: Phillips Screwdriver, Pencil.

1. Open the Right Secret Storage Drawer (E) and remove the foam packaging. Remove the Tray (O) from the drawer and recycle the packaging. Return the Tray (O) to the drawer. See Figure 1.

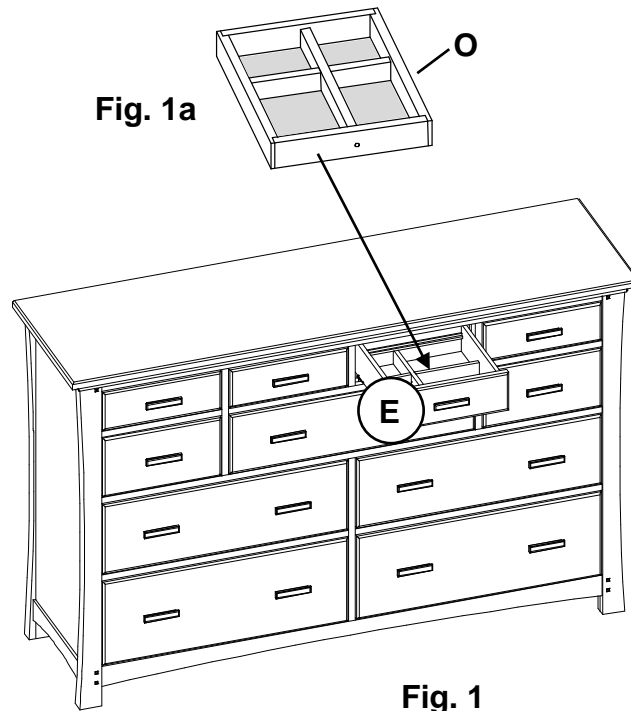

2. There are secret storage areas in the top two middle drawers. To access either of these storage areas, open the Center Upper Middle Drawer (G). Reach in until you find the Hinged Drawer Stop (ZF) that is attached to the bottom right side of the Left Secret Storage Drawer (D) or is attached to the bottom left side of the Right Secret Storage Drawer (E). Pull the Hinged Drawer Stop (ZF) forward and then pull drawer (D or E) out far enough so you can access the concealed storage space. To close the drawer, just push it shut. See Figures 2, 2a, 2b.

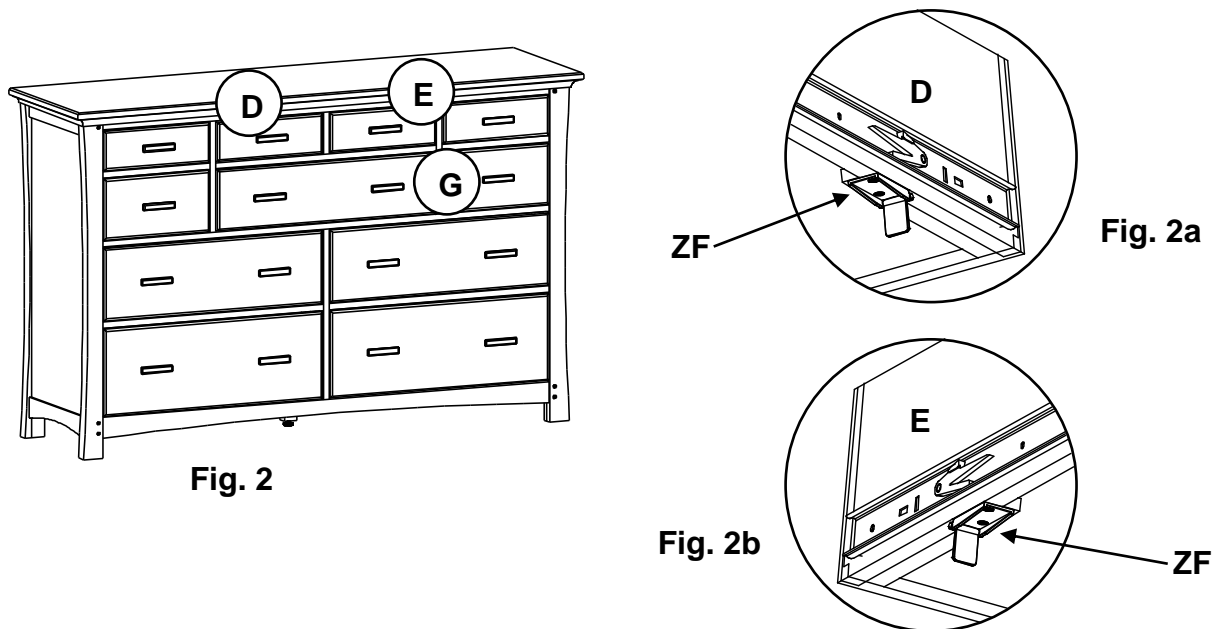

1221AFLSOc; 1221AFDAOc 11-Drawer Prairie City Dresser

Assembly Instructions

- Place the unit at its final destination. Rotate the Small Adjustable Glides (ZQ) found at the corners of the unit and the Adjustable Glide with Hex Nut (V) at the bottom of the Assembled Foot (P) until the unit is level. See Figure 3.

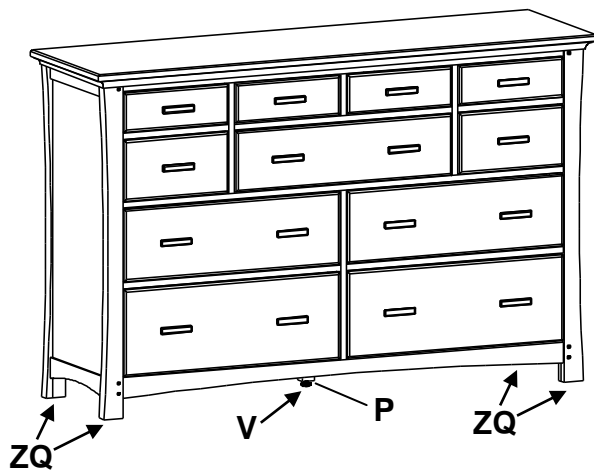

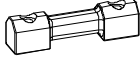





Fig. 3

Continued on Page 6

Furniture Tipping Restraint Instructions

Before you begin this assembly, identify each part and make sure the quantities received match what is on this list. If you need to replace a part, contact Whittier Wood Furniture customer service and refer to the following list for its name and letter code.

Part	Description		Quantity
A	Cam Buckle and Short Strap (installed)		1
B	Plastic Bracket (installed)		1
C	1" x 1000mm Long Strap (installed)		1
D	#8 x 3" Pan Head Screw		2
E	#10 x 1" Oval Head Screw (inserted)		1
F	Washer		1

If you have a stone or tile floor or do not wish to drive screws into the corner of the baseboard and floor see the instruction included inside the tipping restraint kit for an alternate installation.

- Decide where you want to place the piece of furniture in your room. Mark the baseboard with a pencil mark directly behind the location where the tipping restraint is attached to your item. Move the item away from the wall far enough to allow you to access the spot where the baseboard meets the floor. Position the straps and Plastic Bracket (B) as shown in Figures 4 and 4a with the angled corners of the Plastic Bracket (B) firmly placed against the seam of the baseboard and floor. Attach by driving #8 x 3" Pan Head Screws (D) through the holes in the Plastic Bracket (B) into the seam below the baseboard where it meets the floor. See Figures 4 and 4a.

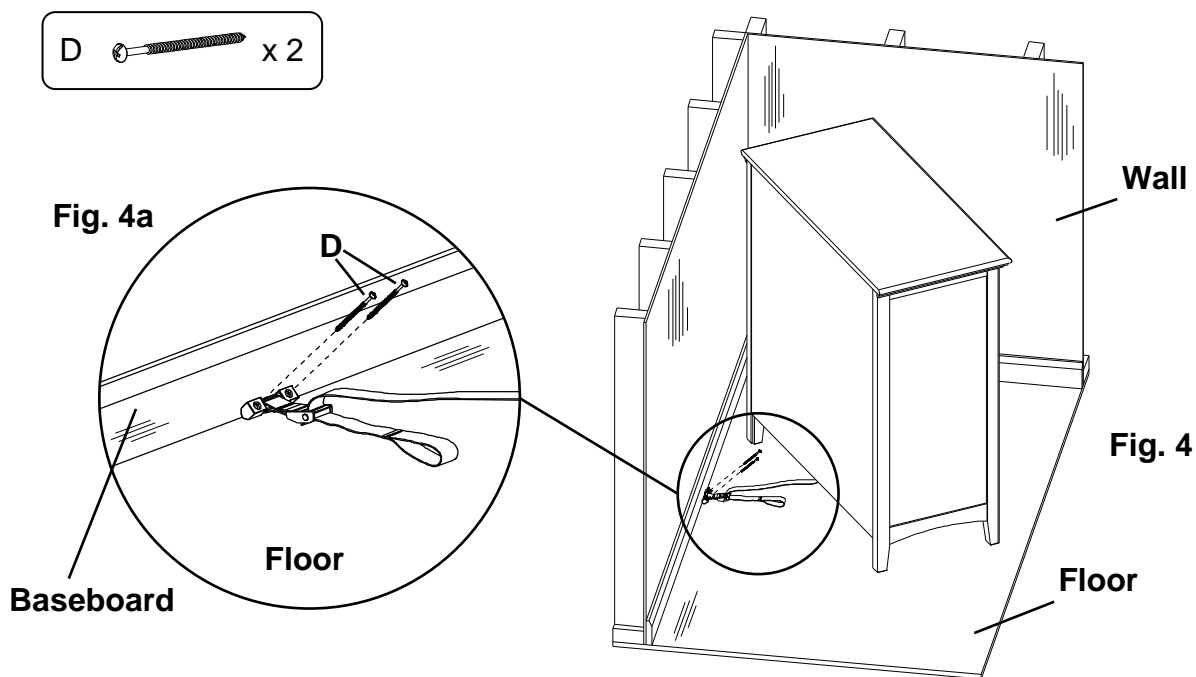

1221AFLSOc; 1221AFDAOc 11-Drawer Prairie City Dresser

Assembly Instructions

5. Move the item back into position against the wall and reach underneath the piece of furniture to grasp the loop in the free end of the strap. Pull the free end of the strap until portion between the Cam Buckle (A) and the back apron of the item is tight. See Figures 5 and 5a. If you need to move the piece of furniture reach beneath and locate the buckle which connects the two sections of the strap and depress the release lever, then pull on the section of strap that is between the buckle and the back apron of the furniture until there is enough slack to allow you to pull the item away from the wall.

