

Model #

2076GAC; 2076CAF 54"W Corner Sound Bar Media Console

GAC = Glazed Antique Cherry finish

CAF = Caffè finish

Assembly Instructions

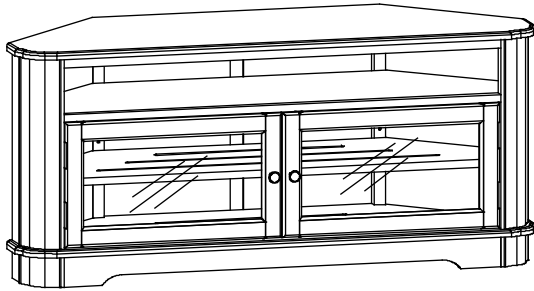

Thank you for allowing us to help you furnish your home. We are certain you will be delighted with your new furniture for many years to come.

IMPORTANT NOTES:

- For normal household use only. *Not* recommended for commercial use.
- Do not climb, sit or stand on this piece of furniture.
- Do not overload the shelf.
- Unload items before you move this unit.



- Handle the glass plates with care. Glass is fragile.
- Before you begin your project, completely read the Assembly Instructions.
- This assembly requires two people.

WARNING

Serious or fatal crushing injuries can occur from furniture tip-over. Use of tip-over restraints may only reduce but not eliminate the risk of tip-over.

To help prevent tip-over:

- Place heaviest items in the bottom drawers.
- Unless specifically designed to accommodate, do not set TVs or other heavy objects on top of this product.
- Never allow children to climb or hang on drawers, doors or shelves.
- Never open more than one drawer at a time.

Warning: At least one tipping restraint kit was included with your piece of Whittier Wood Furniture. When you receive your furniture, be sure to find and properly install the tipping restraint(s). If you cannot locate the restraint(s), please contact us immediately for replacement.

Notice to California Customers

California Prop 65 requires consumer goods to be labeled if any one of 850+ different chemicals or substances, including wood dust, is present even in trace amounts. Drilling, sawing, sanding or machining wood products generates wood dust, a substance known to the State of California to cause cancer. **Warning:** This product contains a chemical or substance known to the State of California to cause cancer, birth defects or other reproductive harm. *California Health and Safety Code Section 25249.6*

DESIGN SUBJECT TO CHANGE WITHOUT NOTICE.

CUSTOMER SERVICE

If you ever have questions about your furniture, please do not hesitate to contact us. In the unlikely event you need a replacement part; we can make those parts available through an authorized Whittier Wood Furniture dealer. If you cannot order replacement parts through your dealer, please contact our customer service department.

Hours: Our friendly customer service staff can be reached:

Monday-Friday 8:00 a.m. to 5:00 p.m. (Pacific Time).

You may leave a message 24 hours a day, seven days a week.

Customer Service: 800-653-3336 • Outside the U.S.: 541-687-0213

Fax: 541-687-2060 • Email: info@whittierwood.com

**Whittier
Wood**
FURNITURE

P.O. Box 2827
Eugene, OR 97402 USA

Production Code:











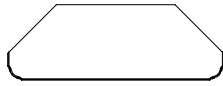
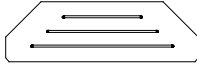
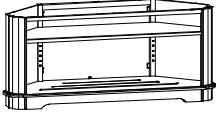
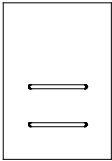
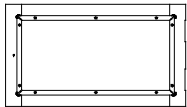
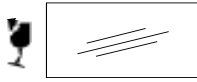

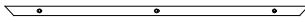
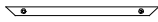

VN

04/16

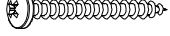
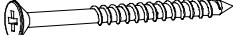

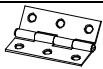

2076GAC; 2076CAF 54"W Corner Sound Bar Media Console

Parts List

Please identify the parts and check that quantities received match those on this list.
If you need to replace a part, refer to the following letter and part name.

Part	Description		Quantity
A	Top (attached)		1
B	Adjustable Shelf (installed)		1
C	Case		1
D	Removable Back (installed)		2
E	Glass Door Frame (installed)		2
F	Door Glass (installed)		2
G	Wood Door Panel (Optional)		2
H	Door Glass Support Rail (attached)		4
I	Door Glass Support Stile (attached)		4
J	#6 x 5/8" Undercut Screw AB (inserted)		32 (GAC) 8 (CAF)
K	#6 x 5/8" Undercut Screw ZN (inserted)		0 (GAC) 24 (CAF)
L	#6 x 1/2" Undercut Screw AB (inserted)		4
M	#6 x 3/4" Flat Head Screw (inserted)		20
N	#6 x 5/8" Philtruss Screw (inserted)		20
O	#8 x 1-1/4" Pan Head Screw (inserted)		32
P	#8 x 2" Black Screw (inserted)		16
Q	#8 x 1-1/2" Machine Screw Tuscan (installed)		2
R	Hinge (attached)		4
S	Drawer Stop (attached)		4
T	Insert Nut (inserted)		2
U	Knob (attached)		2

2076GAC; 2076CAF 54"W Corner Sound Bar Media Console
Parts List

Part	Description		Quantity
V	Turn Button (attached)		4
W	Tuscan Magnetic Lock & Plate (pre-installed sets)		4
X	Small Adjustable Glide (installed)		2
Y	Tack Glide (attached)		3
ZA	Shelf Bracket (installed)		4
TS	Media Tipping Restraint (attached)		1 set

2076GAC; 2076CAF 54"W Corner Sound Bar Media Console

Assembly Instructions

Tool Required: Phillips Screwdriver, Pencil.

1. Move the unit to its final destination. To level the unit, turn the Small Adjustable Glides (X) found at the bottom left and right front corners. See Figure 1.

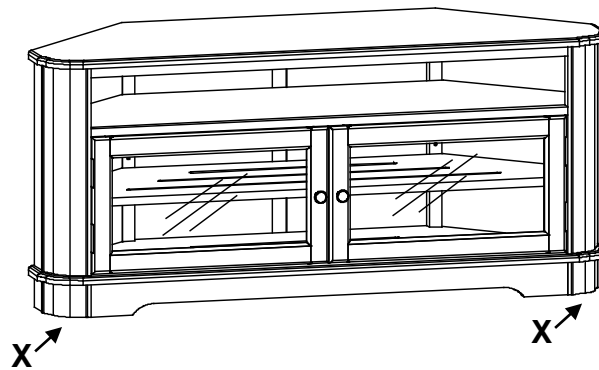

Fig. 1

2. Two Wood Door Panels (G) have been included as an optional replacement for the Door Glass (F). To install the optional Wood Door Panels (G), remove the doors from the unit and place them face down on a clean, protected surface. **DO NOT LEAN ON THE GLASS AT ANY TIME.** Remove the screws from the Door Glass Support Rails (H) and Door Glass Support Stiles (I) and carefully remove Door Glass (F). See Figures 2 and 2a. Place the good face of the Wood Door Panels (G) within the Door Frames (E) face down and reattach the Rails and Stiles with the #6 x 3/4" Flat Head Screws (M). See Figure 2b. Reattach Doors to the Media Console. See Figures 2, 2a, 2b.

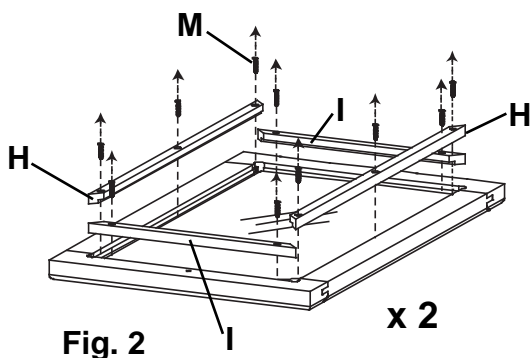
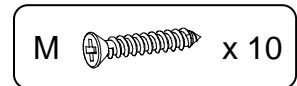

Fig. 2

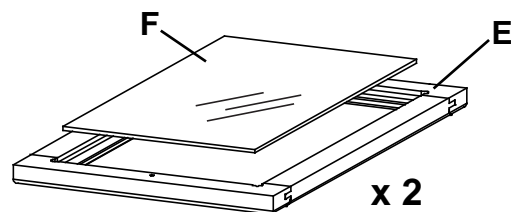

Fig. 2a

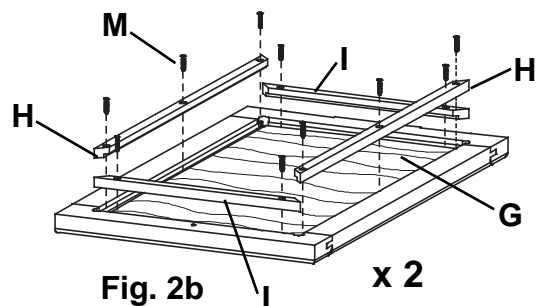

Fig. 2b

2076GAC; 2076CAF 54"W Corner Sound Bar Media Console

Assembly Instructions

3. To place your media components and access wires more easily, you may want to detach the Removable Backs (D). To do so, unlock the Turn Buttons (V) as shown in Figures 3 and 3a. Slide the Backs away and place them off to the side. To put them back into place, slide the Backs behind the Drawer Stops (S) and position the Turn Button so that it is locked. See Figure 3b.

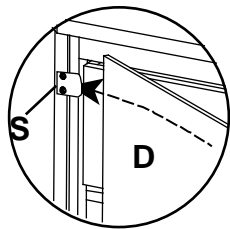

Fig. 3a

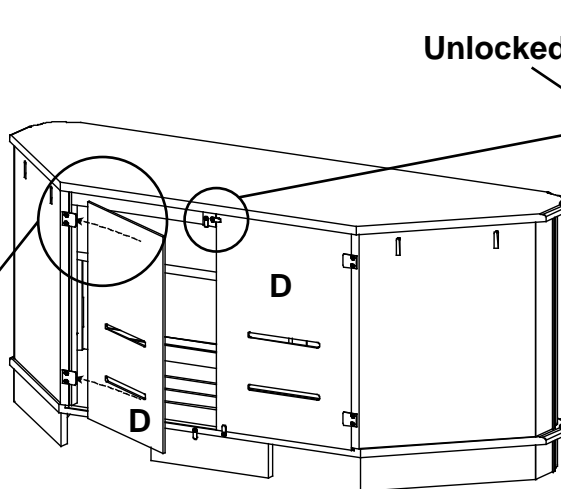

Fig. 3

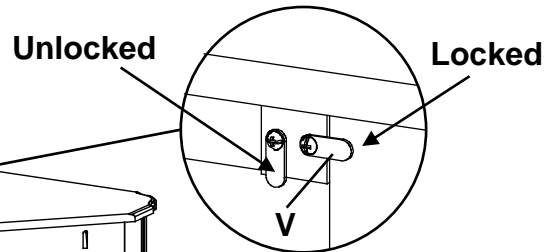

Fig. 3b

4. To move the Adjustable Shelf (B), remove the #6 x 1/2" Undercut Screws (L) and the Shelf (B). Reposition the Shelf Brackets (ZA) to the desired positions, replace the shelf and insert the screws. See Figures 4 and 4a.

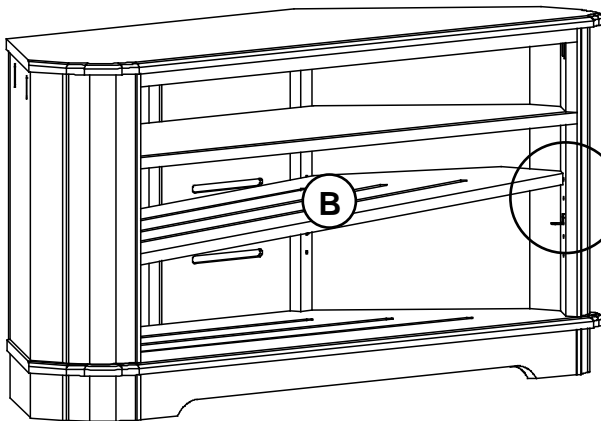

Fig. 4

Doors removed for illustration purposes.

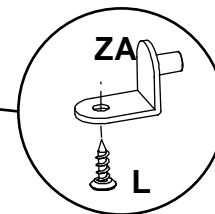
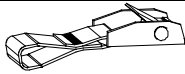
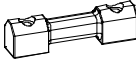





Fig. 4a

Continued on Page 6

Furniture Tipping Restraint Instructions

Before you begin this assembly, identify each part and make sure the quantities received match what is on this list. If you need to replace a part, contact Whittier Wood Furniture customer service and refer to the following list for its name and letter code.

Part	Description		Quantity
A	Cam Buckle and Short Strap (installed)		1
B	Plastic Bracket (installed)		1
C	1" x 1000mm Long Strap (installed)		1
D	#8 x 3" Pan Head Screw		2
E	#10 x 1" Oval Head Screw (inserted)		1
F	Washer		1

If you have a stone or tile floor or do not wish to drive screws into the corner of the baseboard and floor see the instruction included inside the tipping restraint kit for an alternate installation.

- Decide where you want to place the piece of furniture in your room. Mark the baseboard with a pencil mark directly behind the location where the tipping restraint is attached to your item. Move the item away from the wall far enough to allow you to access the spot where the baseboard meets the floor. Position the straps and Plastic Bracket (B) as shown in Figures 5 and 5a with the angled corners of the Plastic Bracket (B) firmly placed against the seam of the baseboard and floor. Attach by driving #8 x 3" Pan Head Screws (D) through the holes in the Plastic Bracket (B) into the seam below the baseboard where it meets the floor. See Figures 5 and 5a.

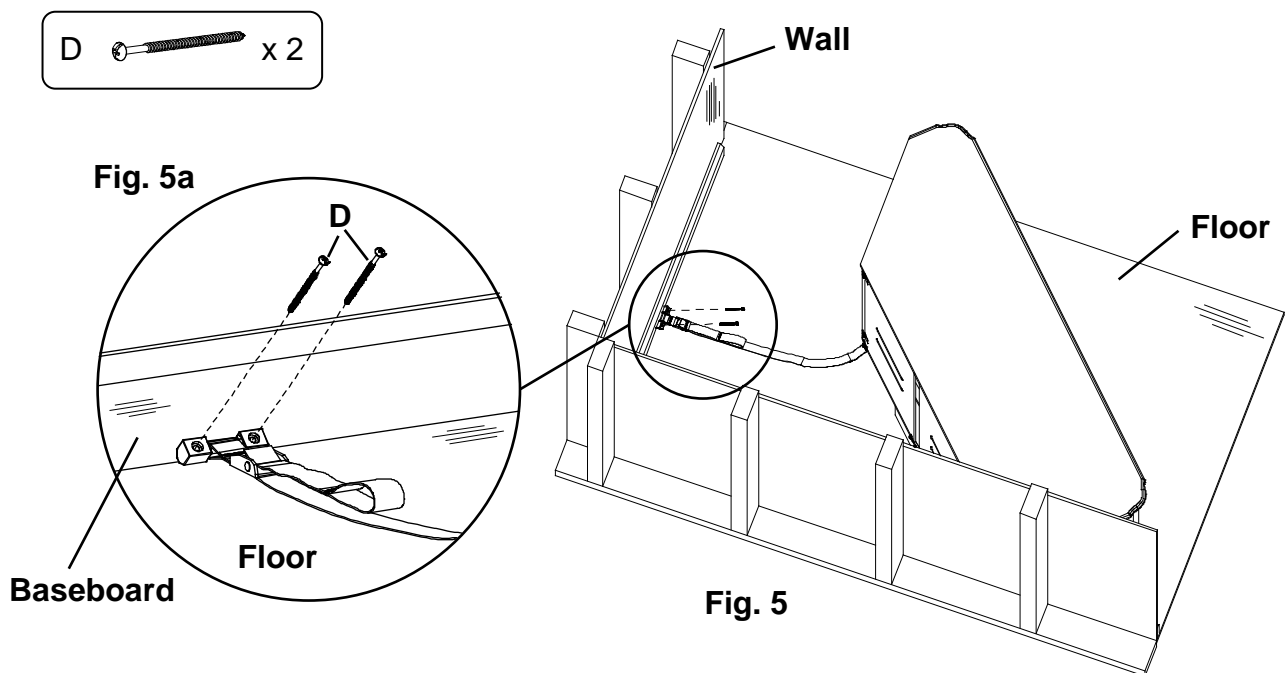

2076GAC; 2076CAF 54"W Corner Sound Bar Media Console

Assembly Instructions

6. Move the item back into position against the wall and reach behind the piece of furniture to grasp the loop in the free end of the strap. Pull the free end of the strap until portion between the Cam Buckle (A) and the back apron of the item is tight. See Figures 6 and 6a. If you need to move the piece of furniture reach behind and locate the buckle which connects the two sections of the strap and depress the release lever, then pull on the section of strap that is between the buckle and the back apron of the furniture until there is enough slack to allow you to pull the item away from the wall.

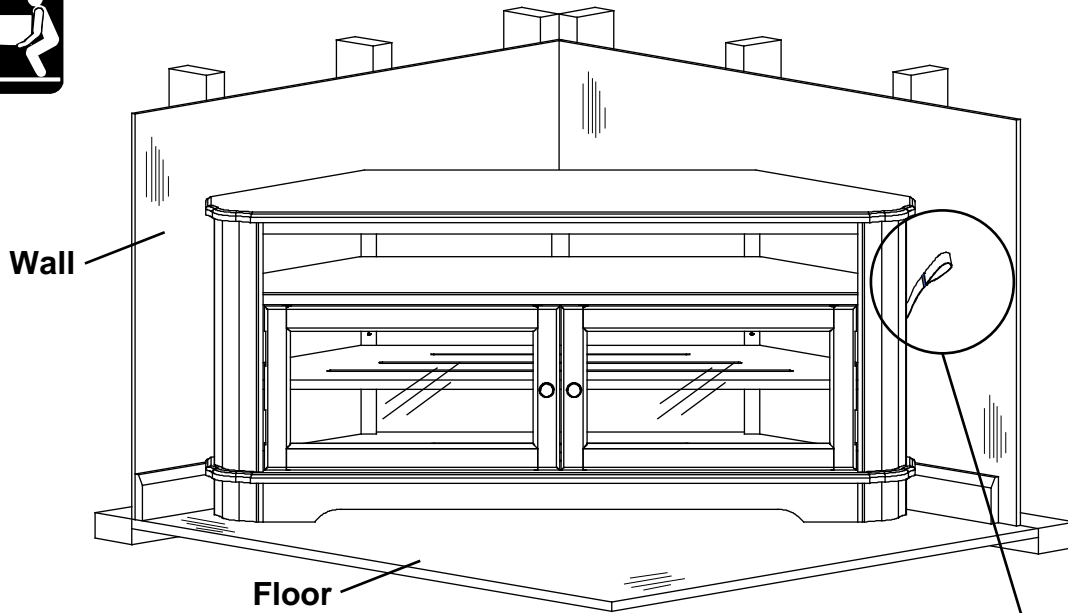

Fig. 6

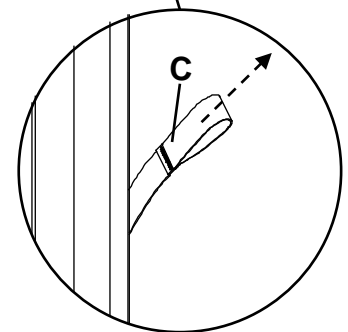

Fig. 6a