

# Cascade Bed Collection

## Glazed Black Cherry finish

### Assembly Instructions

#### Model

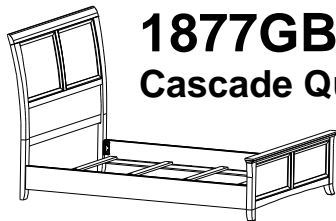

**1877GBCHa**  
Cascade Queen Bed



**1882GBCHa**  
Cascade King Bed

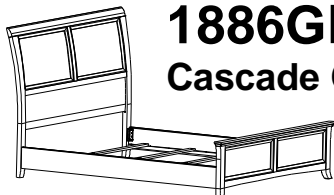

**1886GBCHa**  
Cascade Cal-King Bed

#### **Congratulations!**

*This fine piece of furniture will make a gorgeous addition to your home. For the best results, read the Assembly Instructions before you begin your project.*

#### **IMPORTANT NOTES:**

- For normal household use only. *Not* recommended to use these units in a commercial setting.
- Remove items before you move this unit.
- Before you load or move this unit, tighten all screws and supports.
- Before you begin your project, completely read the Assembly Instructions.
- Store this item: 1- in its box; 2- in a dry place; 3- in temperatures that range from 40°F to 90°F (not on a cold and possibly damp cement floor).
- Periodically inspect your furniture for any loose glue joints, screws or any other problem that might affect the stability of your furniture. Tighten or repair as needed.
- This assembly requires two people.

#### **⚠ WARNING**

##### **Notice to California Customers**

California Prop 65 requires consumer goods to be labeled if any one of 850+ different chemicals or substances, including wood dust, is present even in trace amounts. Drilling, sawing, sanding or machining wood products generates wood dust, a substance known to the State of California to cause cancer. **Warning:** This product contains a chemical or substance known to the State of California to cause cancer, birth defects or other reproductive harm. *California Health and Safety Code Section 25249.6*

**DESIGN SUBJECT TO CHANGE WITHOUT NOTICE.**

**☎ CALL US FIRST!** *Do not return this item to the store.*

**Service Policy:** We will replace any part that is defective, missing or damaged during assembly. For a replacement part, phone, fax, mail or email your request to the Whittier Wood Products customer service department.

**Hours:** Our friendly customer service staff can be reached Monday-Friday 7:00 a.m. to 5:00 p.m. (Pacific Time). You may leave a message 24 hours a day, seven days a week.

**To Order:** Provide the finish and furniture model number (above the illustration of your unit), the part letter, production code, quantity needed, reason for replacement and your full name, address and telephone number.

*Parts ship from our Eugene, Oregon factory within one or two business days from the time we receive your request. Please allow five to ten business days for delivery.*

**800-653-3336** • Outside the U.S. or Canada: 541-687-0213 • Fax: 541-687-2060  
www.whittierwood.com • P.O. Box 2827 • Eugene, Oregon 97402, U.S.A.

**Whittier  
Wood**  
FURNITURE

P.O. Box 2827  
Eugene, OR 97402 USA

Production Code:

VN











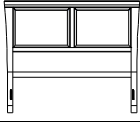
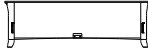
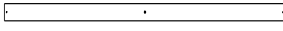
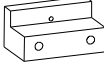

07/13

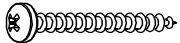
**1877GBCHa Cascade Queen Bed; 1882GBCHa Cascade King Bed;  
1886GBCHa Cascade Cal-King Bed**

*Parts List*

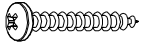
Please identify the parts and check that quantities received match those on this list.  
If you need to replace a part, refer to the following letter and part name.

**1879GBCHa Queen Bed (Headboard/Footboard Kit)  
1884GBCHa King Bed (Headboard/Footboard Kit)  
1888GBCHa Cal-King Bed (Headboard/Footboard Kit)**

Part	Description		Quantity
A	Headboard		1
B	Footboard		1
C	Slat		5
D	Slat Support (attached)		1
F	T-Nut (inserted)		5
G	Hanger Bolt (inserted)		4
I	Male Bracket (attached)		4
K	#8 x 1-1/4" Black Screw		26 (16 inserted)
L	#8 x 1-3/4" Pan Head Screw (inserted)		5
M	1/4" Lock Washer		8
N	1/4" x 1/2" Hex Bolt		8
O	5mm Hex Wrench		1
S	#8 x 20mm Pan Head Screw (inserted)		12
T	Adjustable Glide with Hex Nut (installed)		4
U	Assembled Foot		4
V	5/16" x 3/4" Insert Nut (inserted)		4

*1879 shown in illustrations.*

**1877GBCHa Cascade Queen Bed; 1882GBCHa Cascade King Bed;  
1886GBCHa Cascade Cal-King Bed**

*Parts List*

**1880GBCH Queen/King Bed Rail Kit;  
1889GBCH Cal-King Bed Rail Kit**

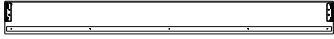
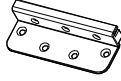
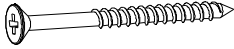
<b>Part</b>	<b>Description</b>	<b>Quantity</b>
J	#8 x 1" Black Screw (inserted) 	16
P	Side Rail 	2
Q	Female Bracket (attached) 	4
R	#8 x 2" Black Screw (inserted) 	22

*1880 shown in illustrations.*

# 1877GBCHa Cascade Queen Bed; 1882GBCHa Cascade King Bed; 1886GBCHa Cascade Cal-King Bed

## Assembly Instructions

This assembly requires two people.

### Tools Required: 5mm Hex Wrench (provided) and Phillips Screwdriver

1. Remove the Slats (C) from the back of the Headboard (A) as seen in Figure 1 and place them off to the side.

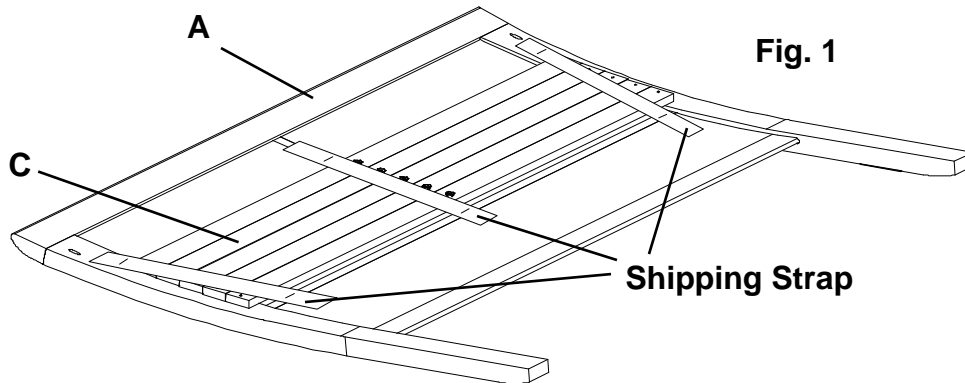

2. Using the Hex Wrench (O) provided, attach the Rails (P) to the Headboard (A) with four 1/4" x 1/2" Hex Bolts (N) and 1/4" Lock Washers (M) as shown in Figures 2 and 2a.

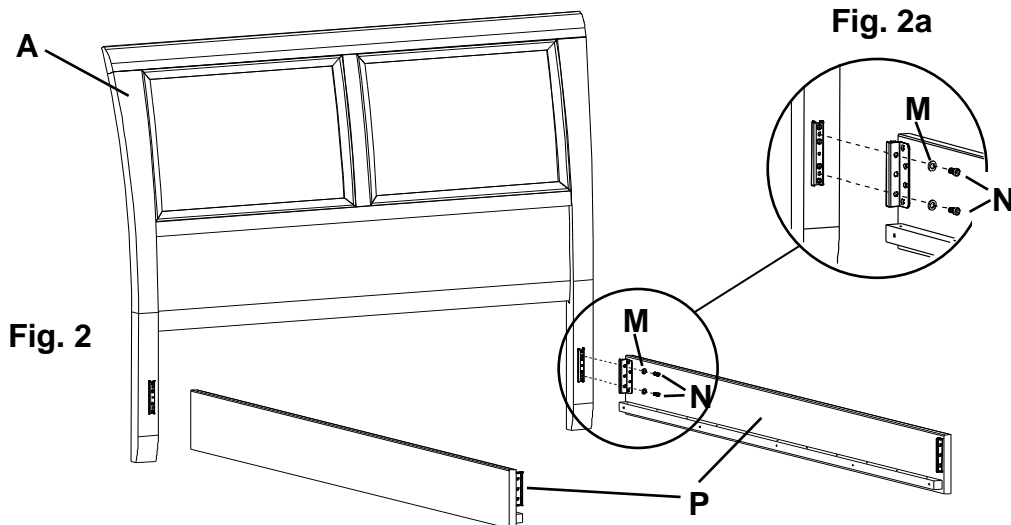
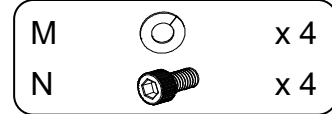



# 1877GBCHa Cascade Queen Bed; 1882GBCHa Cascade King Bed; 1886GBCHa Cascade Cal-King Bed

## Assembly Instructions

This assembly requires two people.

- Using the Hex Wrench (O) provided, attach the Footboard (B) to the Rails with four 1/4" x 1/2" Hex Bolts (N) and 1/4" Lock Washers (M) as shown in Figures 3 and 3a.



M		x 4
N		x 4

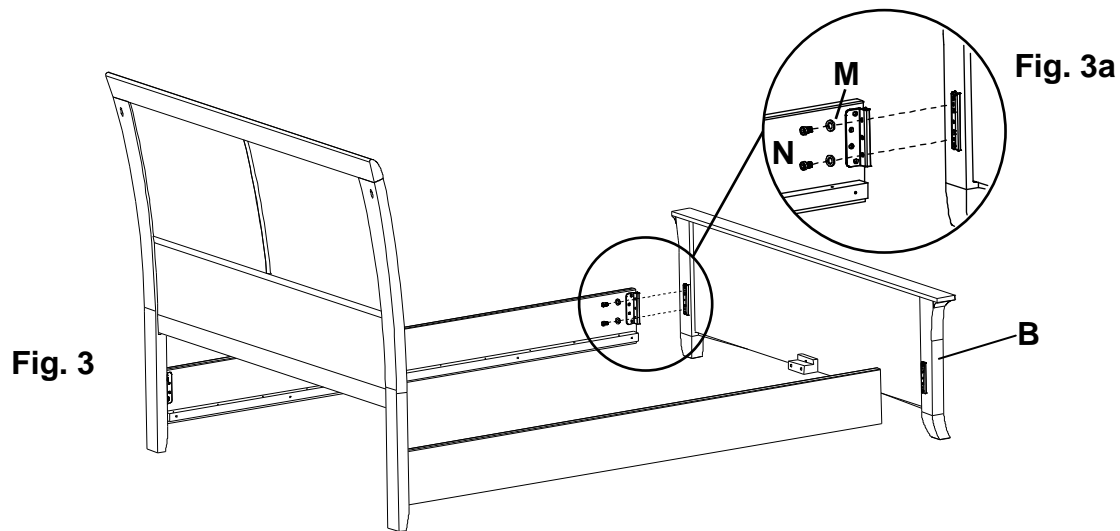

- Attach an Assembled Foot (U) to four of the five Slats (C) as shown in Figure 4.

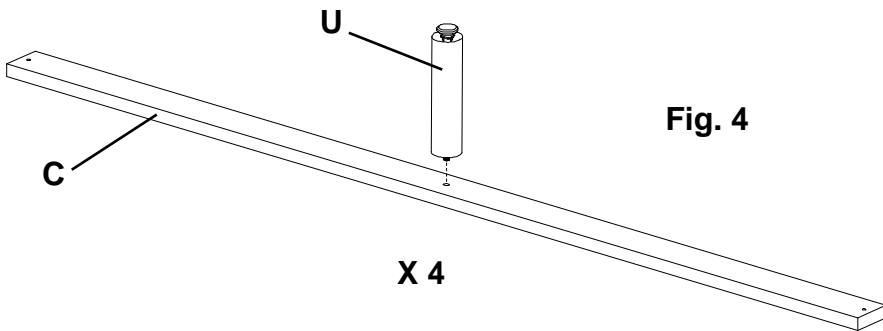

**1877GBCHa Cascade Queen Bed; 1882GBCHa Cascade King Bed;  
1886GBCHa Cascade Cal-King Bed**

*Assembly Instructions*

This assembly requires two people.



5. Place the bed at its final location.
6. Position the Slats (C) on the bottom edges of the rails and place the slat without the Assembled Foot nearest to the Footboard. Attach with #8 x 1-1/4" Black Screws (K). See Figure 6.

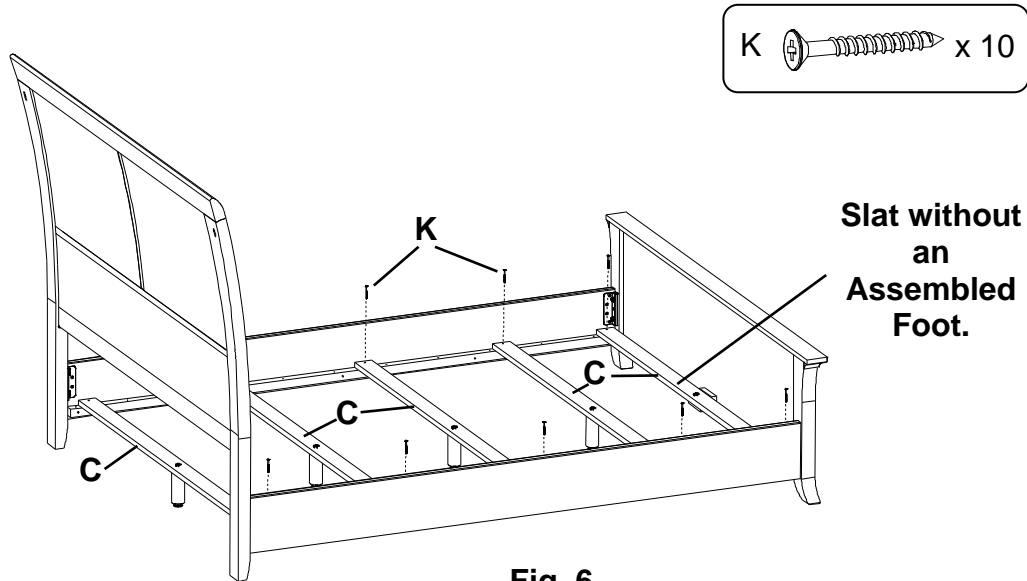

7. Adjust the Adjustable Glides with Hex Nut (T) on the Assembled Feet (U) so the Glides are touching the floor, and carrying weight. If the feet need additional adjustment after your Box Spring and Mattress are placed on the bed, the Adjustable Glides with Hex Nut (T) can be turned using a 7/16" wrench.

